

PENTAX™

SLR Digital Camera

K110D

Operating Manual



For optimum camera performance,
please read the Operating Manual
before using the camera.

Thank you for purchasing the PENTAX *K110D* Digital Camera. Please read this manual before using the camera in order to get the most out of all the features and functions. Keep this manual safe, as it can be a valuable tool in helping you to understand all the camera's capabilities.

Lenses you can use

In general, lenses that can be used with this camera are DA, D FA and FA J lenses and lenses that have an Aperture **A** (Auto) position.

To use any other lens or accessory, see p.37 and p.184.

Regarding copyrights

Images taken using the *K110D* that are for anything other than personal enjoyment cannot be used without permission according to the rights as specified in the Copyright Act. Please take care, as there are even cases where limitations are placed on taking pictures even for personal enjoyment during demonstrations, performances or of items on display. Images taken with the purpose of obtaining copyrights also cannot be used outside the scope of use of the copyright as laid out in the Copyright Act, and care should be taken here also.

Regarding trademarks

- PENTAX and smc PENTAX are trademarks of PENTAX Corporation.
- The SD logo  is a trademark.
- All other brands or product names are trademarks or registered trademarks of their respective owners.

To users of this camera

- There is a possibility that recorded data may be erased or that the camera may not function correctly when used in surroundings such as installations generating strong electromagnetic radiation or magnetic fields.
- The liquid crystal panel used in the LCD display is manufactured using extremely high precision technology. Although the level of functioning pixels is 99.99% or better, you should be aware that 0.01% or fewer of the pixels may not illuminate or may illuminate when they should not. However, this has no effect on the recorded image.

This product supports PRINT Image Matching III. PRINT Image Matching enabled digital still cameras, printers and software help photographers to produce images more faithful to their intentions. Some functions are not available on printers that are not PRINT Image Matching III compliant.

Copyright 2001 Seiko Epson Corporation. All Rights Reserved.

PRINT Image Matching is a trademark of Seiko Epson Corporation.

The PRINT Image Matching logo is a trademark of Seiko Epson Corporation.

Regarding PictBridge

PictBridge allows the user to connect the printer and digital camera directly, using the unified standard for the direct printout of images. You can print images directly from the camera through a few simple operations.

- There is a possibility that the illustrations and the display screen of the LCD monitor in this manual are different from the actual product.

FOR SAFE USE OF YOUR CAMERA

We have paid close attention to the safety of this product. When using this product, we request your special attention regarding items marked with the following symbols.



Warning

This symbol indicates that violating this item could cause serious personal injury.



Caution

This symbol indicates that violating this item could cause minor or medium personal injury, or material loss.

ABOUT THE CAMERA



Warning

- Do not disassemble or modify the camera. High voltage areas are present inside the camera, with the risk of electric shock.
- If the camera interior is exposed due to dropping or otherwise damaging the camera, never touch the exposed portion. There is the risk of electric shock.
- To avoid the risk of it being swallowed by mistake, keep the SD Memory Card out of the reach of small children. Seek medical attention immediately if a memory card is accidentally swallowed.
- Wrapping the strap around your neck is dangerous. Take care that small children do not hang the strap over their necks.
- Do not look directly at the sun through the camera with the telephoto lens attached, as viewing the sun may damage your eyes. Viewing the sun directly with the telephoto lens may lead to a loss of eyesight.
- Be sure to store batteries out of the reach of children. Seek medical assistance immediately if a battery is accidentally swallowed.
- Always use the AC adapter exclusively developed for this product, with the specified power and voltage. Using an AC adapter not exclusive to this product, or using the exclusive AC adapter with an unspecified power or voltage can cause a fire, electric shock, or camera breakdown.
- If any irregularities occur during use, such as smoke or a strange odor, stop use immediately, remove the batteries or the AC adapter, and contact your nearest PENTAX service center. Continued use could cause a fire or electric shock.
- During thunderstorms, unplug and discontinue use of the AC adapter. Continued use could cause equipment failure, a fire, or electric shock.



Caution

- Do not short the batteries or dispose of the batteries in fire. Do not disassemble the batteries. The batteries could explode or catch fire.
- Of the batteries that can be used in this camera (AA Ni-MH batteries, AA lithium batteries, AA alkaline batteries and CR-V3), only the Ni-MH batteries can be recharged. Recharging other batteries can cause a fire or explosion.
- Remove the batteries from the camera immediately if they become hot or begin to smoke. Be careful not to burn yourself during removal.
- Some portions of the camera heat up during use. There is the risk of low temperature burns when holding such portions for long periods.
- Do not place your finger over or cover the flash with clothing when discharging the flash. Fingers or clothing may be burned.

PRECAUTIONS FOR BATTERY USAGE

- Only use specified batteries with this camera. Use of other batteries can cause a fire or explosion.
- Replace all the batteries at the same time. Do not mix battery brands, type or an old battery with a new one. It may cause explosion or a fire.
- The batteries should be inserted correctly with regard to polarity (+ and -) marked on the batteries and the camera. Not inserting batteries correctly may cause explosion or a fire.
- Do not disassemble the batteries. Of the batteries that can be used in this camera, only the Ni-MH batteries can be recharged. Disassembling the batteries or attempting to charge non-rechargeable batteries could result in explosion or leakage.

Care to be Taken During Handling

- When traveling, take the Worldwide Service Network that is included in the package. This will be useful if you experience problems abroad.
- When the camera has not been used for a long time, confirm that it is still working properly, particularly prior to taking important pictures (such as at a wedding or during traveling). Pictures cannot be guaranteed if recording, playback or transferring your data to a computer, etc. is not possible due to a malfunction of your camera or recording media (SD Memory Card), etc.
- Do not clean the product with organic solvents such as thinner or alcohol benzene.

- Do not subject the camera to high temperatures or high humidity. Do not leave the camera in a vehicle, as the temperature can get very high.
- Do not store the camera with preservatives and chemicals. Storage in high temperatures and high humidity can cause molding. Remove from case and store in a dry and well-ventilated location.
- This camera is not waterproof, and should not be used in the rain or where the camera could get wet.
- Do not subject the camera to strong vibrations, shocks, or pressure. Use a cushion to protect the camera from vibrations of motorcycles, automobiles, or ships.
- The temperature range for camera use is 0°C to 40°C (32°F to 104°F).
- The LCD display may appear black under high temperatures, but will return to normal as temperatures normalize.
- The LCD display may respond more slowly at low temperatures. This is due to liquid crystal properties, and is not a fault.
- Periodic inspections are recommended every one to two years to maintain high performance.
- Sudden temperature changes will cause condensation on the inside and outside of the camera. Place the camera in your bag or a plastic bag, removing the camera after temperature of the camera and surroundings are equalized.
- Avoid contact with garbage, mud, sand, dust, water, toxic gases, or salts. These could cause a camera breakdown. Wipe dry any rain or water drops on the camera.
- Refer to “Precautions When Using the SD Memory Card” (p.30) regarding the SD Memory Card.
- Use a lens brush to remove dust accumulated on the lens or viewfinder. Never use a spray blower for cleaning as it may damage the lens.
- Please do not press forcefully on the LCD monitor. This could cause breakage or malfunction.

Regarding Product Registration

In order to better serve you, we request that you complete the product registration, which can be found on the CD-ROM supplied with the camera or on the PENTAX website. Thank you for your cooperation.

Refer to the PENTAX PHOTO Browser 3/PENTAX PHOTO Laboratory 3 Operating Manual (Windows users: p.9, Mac OS users: p.10) for more information.

Contents

| | |
|---|---|
| FOR SAFE USE OF YOUR CAMERA..... | 1 |
| ABOUT THE CAMERA..... | 1 |
| PRECAUTIONS FOR BATTERY USAGE | 2 |
| Care to be Taken During Handling | 2 |
| Contents | 4 |
| Composition of the Operating Manual | 9 |

Before Using Your Camera **11**

| | |
|--|-----------|
| <i>K110D</i> Camera Characteristics | 12 |
| Checking the Contents of the Package..... | 13 |
| Names of Working Parts | 14 |
| Camera..... | 14 |
| LCD Monitor Indications | 16 |
| Viewfinder Indications..... | 20 |
| LCD Panel Indications | 22 |

Getting Started **23**

| | |
|---|-----------|
| Attaching the Strap | 24 |
| Inserting the Batteries | 25 |
| Batteries..... | 26 |
| Battery Level Indicator | 27 |
| Approximate Image Storage Capacity and Playback Time (new batteries) | 27 |
| Using the AC Adapter (Optional) | 28 |
| Inserting/Removing the SD Memory Card | 29 |
| Recorded Pixels and Quality Level..... | 31 |
| Turning the Camera On and Off..... | 32 |
| Initial Settings | 33 |
| Setting the Display Language..... | 33 |
| Setting the Date and Time..... | 35 |
| Attaching the Lens..... | 37 |
| Adjusting the Viewfinder Diopter | 39 |





Basic Operations

41

| | |
|---|-----------|
| Basic Shooting Operation | 42 |
| Holding the Camera..... | 42 |
| Letting the Camera Choose the Optimal Settings | 43 |
| Selecting the Appropriate Capturing Mode for Scenes | 47 |
| Selecting the Shooting Scene..... | 48 |
| Using a Zoom Lens | 50 |
| Using the Built-in Flash | 51 |
| Other Shooting Modes | 55 |
| Continuous Shooting | 55 |
| Self-Timer Shooting | 57 |
| Remote Control Shooting (Remote Control F: Sold Separately) | 61 |
| Using Mirror Up Function to Prevent Camera Shake | 64 |
| Playing Back Still Pictures | 65 |
| Playing Back Images | 65 |
| Enlarging Playback Images | 67 |
| Nine-Image Display | 68 |
| Slideshow | 70 |
| Connecting the Camera to AV Equipment | 72 |
| Processing Images with Filters | 73 |
| Deleting Images | 76 |
| Deleting a Single Image..... | 76 |
| Deleting All Images..... | 77 |
| Deleting Selected Images (from Nine-Image Display)..... | 78 |
| Protecting Images from Deletion (Protect)..... | 80 |
| Setting the Printing Service (DPOF) | 82 |
| Printing Single Images..... | 82 |
| Settings for All Images..... | 83 |
| Printing Using PictBridge | 85 |
| Setting [Transfer Mode] | 86 |
| Connecting the Camera to the Printer | 87 |
| Printing Single Images..... | 88 |
| Printing All Images..... | 90 |
| Printing Images Using the DPOF Settings..... | 92 |
| Disconnecting the USB Cable | 92 |

Menu Reference

93

| | |
|--|------------|
| Using the Button Functions | 94 |
| Capture Mode | 94 |
| Playback Mode | 96 |
| Using the Menu | 98 |
| How to Operate the Menu..... | 98 |
| [ Rec. Mode] Menu Setting Items | 100 |
| [ Playback] Menu Setting Items | 100 |
| [ Set-up] Menu Setting Items | 101 |
| [ Custom Setting] Menu Setting Items | 102 |
| Using the Fn Menu | 104 |
| Capture Mode | 104 |
| Playback Mode | 105 |
| Using the Mode Dial..... | 106 |

Function Reference

109

| | |
|---|------------|
| Setting the Recorded Pixels and Quality Level..... | 110 |
| Setting the Image Tone | 110 |
| Setting the Recorded Pixels | 111 |
| Setting the Quality Level..... | 112 |
| Setting the Saturation/Sharpness/Contrast | 113 |
| Setting the White Balance | 114 |
| Setting the Sensitivity | 117 |
| Setting the Color Space..... | 119 |
| Focusing | 120 |
| Using the Autofocus..... | 120 |
| Setting the AF Mode | 123 |
| Selecting the Focusing Area (AF Point)..... | 124 |
| Fixing the Focus (Focus Lock)..... | 126 |
| Adjusting the Focus Manually (Manual Focus)..... | 128 |
| Setting the Exposure | 130 |
| Effect of Aperture and Shutter Speed..... | 130 |
| Selecting the Metering Method..... | 132 |
| Changing the Exposure Mode | 134 |
| Setting the Exposure | 143 |
| Changing the Exposure and Shooting (Auto Bracket) | 145 |

| | |
|--|------------|
| Checking the Composition, Exposure and Focus Before Shooting | 148 |
| Displaying the Preview | 148 |
| Selecting the Preview Method | 149 |
| Using the Built-in Flash | 150 |
| Compensating Flash Output | 150 |
| Allowing Shooting while Charging Flash..... | 151 |
| Flash Characteristics in Each Exposure Mode | 151 |
| Distance and Aperture when Using the Built-in Flash | 152 |
| DA, D FA , FA J, FA and F Lens Compatibility with the Built-in Flash..... | 154 |
| Using an External Flash (Optional)..... | 156 |
| Settings During Playback..... | 163 |
| Changing Playback Display Method | 163 |
| Setting the Slideshow Display Interval..... | 164 |
| Camera Settings..... | 165 |
| Formatting the SD Memory Card..... | 165 |
| Turning the Beep On and Off..... | 166 |
| Changing the Date and Time and the Display Style | 166 |
| Setting the World Time | 167 |
| Setting the Display Language..... | 170 |
| Turning the Guide Display On and Off..... | 170 |
| Adjusting the Brightness of the LCD Monitor | 171 |
| Selecting the Video Output Format..... | 171 |
| Setting Auto Power Off | 172 |
| Selecting the Folder Name | 172 |
| Resetting the File Number | 173 |
| Setting the Display Instant Review and Digital Preview | 173 |
| Resetting to Default Settings | 175 |
| Resetting Rec. Mode/Playback/Set-up Menu | 175 |
| Resetting the Custom Function Menu | 176 |

| | |
|---|------------|
| Default Settings | 178 |
| Functions Available with Various Lens Combinations | 182 |
| Notes on [Using Aperture Ring] | 184 |
| Cleaning the CCD | 185 |
| Optional Accessories | 187 |
| Error Messages | 190 |
| Troubleshooting | 192 |
| Main Specifications | 195 |
| Specifications for Remote Control F (Optional) | 197 |
| Glossary | 198 |
| Index | 202 |
| WARRANTY POLICY | 206 |

Composition of the Operating Manual

This operating manual contains the following chapters.

1 Before Using Your Camera

Explains camera characteristics, accessories and the names of various parts.

2 Getting Started

Explains your first steps from purchasing the camera to taking pictures. Be sure to read it and follow the instructions.

3 Basic Operations

Explains the procedures for taking, playing back, and printing still pictures. Read it to learn all of the basic operations about capturing, playing back, and printing.

4 Menu Reference

Explains the functions of *K110D* by buttons and menus.



5 Function Reference

Introduces functions to further enhance your *K110D* experience.

6 Appendix

Explains troubleshooting, introduces optional accessories and provides various resources.

The symbols used in this operating manual are explained below.

| | |
|---|---|
|  | Shows reference page number explaining a related operation. |
|  | Shows useful information. |
|  | Shows precautions to take when operating the camera. |

1 Before Using Your Camera

Check the package contents and names of working parts before use.

| | |
|---|-----------|
| <i>K110D</i> Camera Characteristics | 12 |
| Checking the Contents of the Package | 13 |
| Names of Working Parts | 14 |

- Features a 23.5×15.7 mm CCD with 6.1 million effective pixels for high precision and a wide dynamic range.
- Features an AF sensor with 11 focusing points. The central 9 are wide area cross sensors.
- Features a viewfinder similar to that of a conventional 35 mm camera, with a 0.85× magnification and 96% field of view, for easier manual focusing. Also features a superimpose function in which the AF points on the viewfinder illuminate red.
- Uses CR-V3, AA lithium batteries, rechargeable AA Ni-MH batteries or AA alkaline batteries.
- Features a large 2.5-inch LCD monitor with 210,000 pixels and a brightness adjusting function for high-precision/wide-field viewing performance.
- Features a Digital Preview function for checking the image to ensure that the desired result is achieved.
- A user-friendly design has been implemented in various parts of the camera. The large, high-resolution LCD monitor and easy-to-use menus make the camera easier to operate.

The captured area (view angle) will differ between the **K110D** and 35 mm SLR cameras even if the same lens is used because the format size for 35 mm film and CCD are different.

Sizes for 35 mm film and CCD

| | |
|------------------|----------------|
| 35 mm film | : 36×24 mm |
| K110D CCD | : 23.5×15.7 mm |

Angles of view being equal, the focal length of a lens used with a 35 mm camera must be approximately 1.5 times longer than that of **K110D**. To obtain an angle of view framing the same area, divide the focal length of the 35 mm lens by 1.5.

Example) To capture the same image as a 150 mm lens attached to a 35 mm camera

$$150 \div 1.5 = 100$$

Use a 100 mm lens with the **K110D**.

Inversely, multiply the focal length of the lens used with **K110D** by 1.5 to determine the focal length for 35 mm cameras.

Example) If 300 mm lens is used with **K110D**

$$300 \times 1.5 = 450$$

Focal length is equivalent to a 450 mm lens on a 35 mm camera.

The following accessories are packaged with your camera.
Check that all accessories are included.



Hot shoe cover F κ
(Installed on camera)

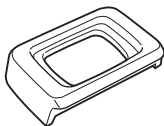

Eyecup F \omicron
(Installed on camera)



ME Viewfinder cap

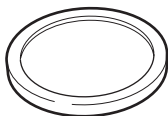

Body mount cover
(Installed on camera)

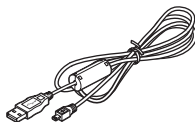

USB cable
I-USB17

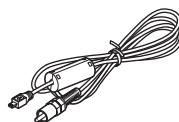

Video cable
I-VC28



Software (CD-ROM)
S-SW53

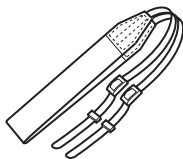

Strap
O-ST53



AA Alkaline batteries*
(four)

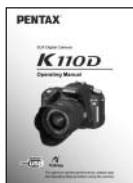

Operating Manual
(this manual)

* The batteries packaged with the camera are for checking the camera's functionality.

Camera

1

Before Using Your Camera

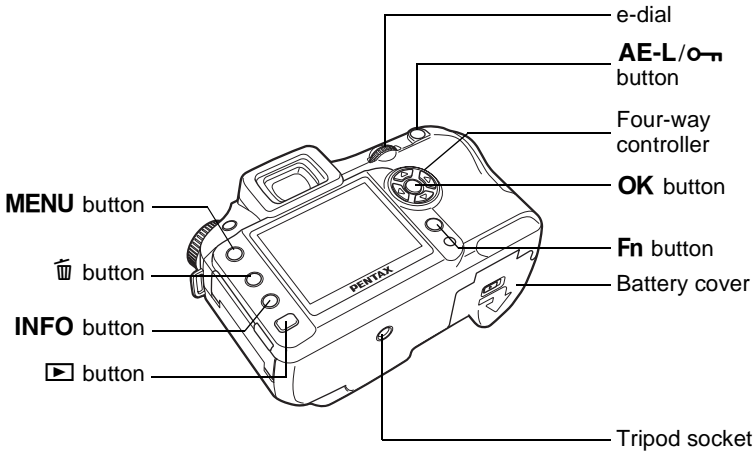
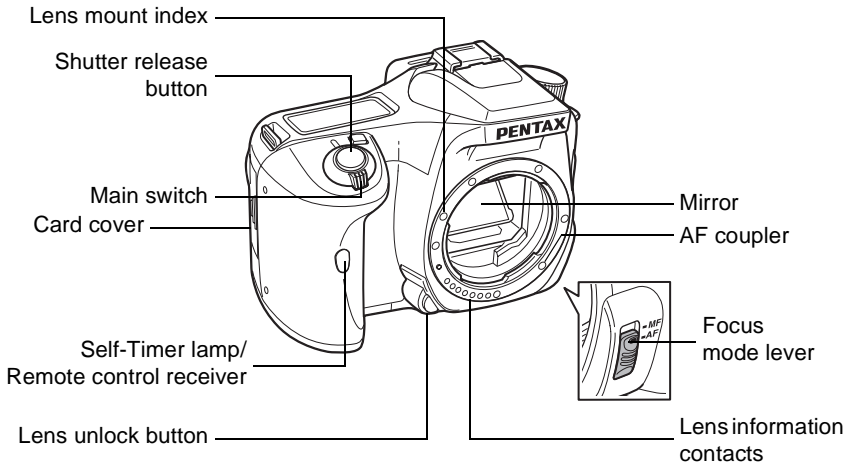

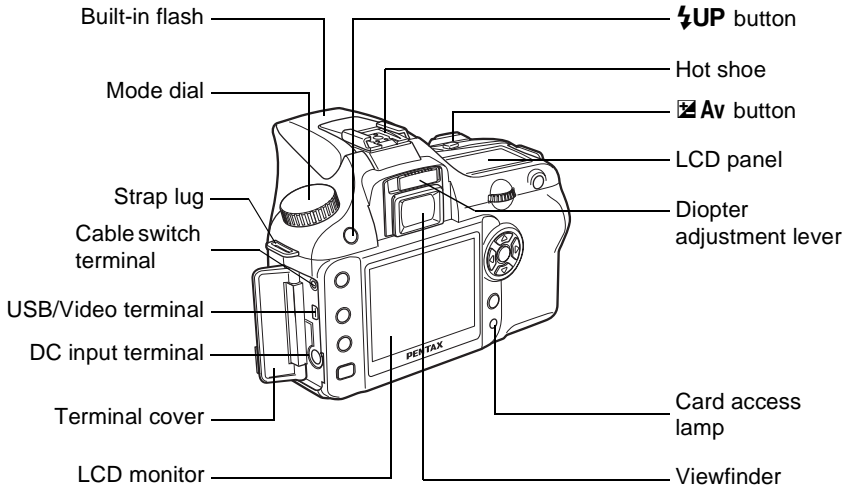

LCD Monitor Indications

The following indicators appear on the LCD monitor depending on the status of the camera.

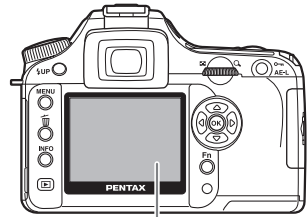

LCD monitor

While Power is On or Operating Mode Dial

Guides appear on the LCD monitor for 3 seconds when the camera is powered on or mode dial is turned.



Select Off for [Guide display] in [X↓ Set-up] to not show indicators. (p.101)

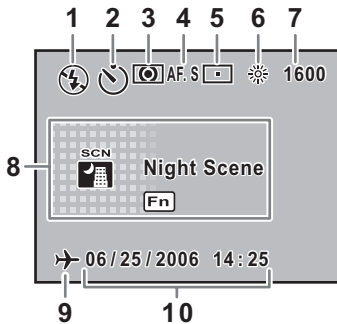

- 1 Flash mode
(Active mode appears) (p.51)
- 2 Drive mode (p.104)
- 3* AE metering (p.132)
- 4 AF mode (p.123)
- 5* AF point switching (p.124)
- 6* White balance (p.114)
- 7* Sensitivity (p.117)
- 8 Shooting mode, Scene mode
(p.106)
- 9* World time warning display (p.167)
- 10 Date and time (p.166)

* Indicators 3, 5, 6 and 7 only appear when a setting other than the default setting is selected. 9 only appears when World Time is On.

Capture Mode

Press the **INFO** button in Capture mode to display the capture function settings on the LCD monitor for 15 seconds.

● Detailed Information

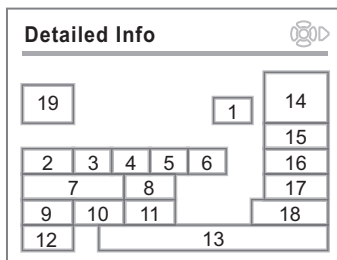
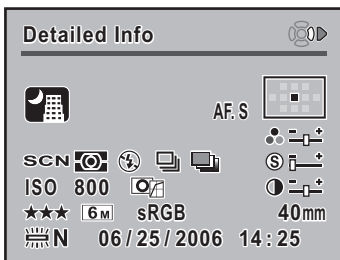

- | | |
|------------------------------|------------------------------|
| 1 AF mode (p.123) | 11 Color space (p.119) |
| 2 Mode dial position (p.106) | 12 White balance (p.114) |
| 3 AE metering (p.132) | 13 Date and time (p.166) |
| 4 Flash mode (p.51) | 14 AF point position (p.124) |
| 5* Drive mode (p.104) | 15 Saturation (p.113) |
| 6* Auto bracket (p.147) | 16 Sharpness (p.113) |
| 7 ISO sensitivity (p.117) | 17 Contrast (p.113) |
| 8 Image tone (p.110) | 18 Lens focal length |
| 9 Quality level (p.112) | 19* Scene mode (p.47) |
| 10 Recorded pixels (p.111) | |

* Indicators 5 and 6 do not appear at the same time. Only one appears at a time. Indicator 19 is only displayed in Scene mode.

Press the four-way controller (⬅️) to view explanation of set Shooting mode.

● Explanation of Set Shooting Mode

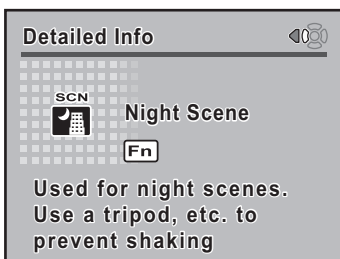

Playback Mode

Every time you press the **INFO** button during playback, the camera switches screen displays in the following order: [Standard] Display, [Histogram] Display, [Detailed Information] Display and [No info. Display] (image only).



You can change the information initially displayed by pressing the button. (p.163)

● Detailed Information

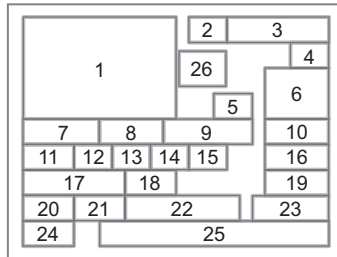
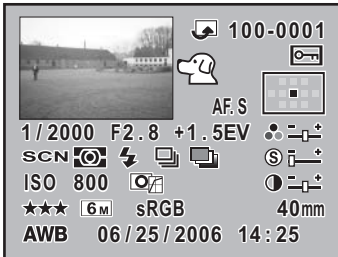

- | | | | |
|-----|--|-----|--------------------------------|
| 1 | Captured image | 14* | Drive mode (p.104) |
| 2 | Rotate icon (p.66) | 15* | Auto bracket (p.147) |
| 3 | Image folder number and file number (p.172, 173) | 16 | Sharpness (p.113) |
| 4 | Protect icon (p.80) | 17 | ISO sensitivity (p.117) |
| 5 | AF mode (p.123) | 18 | Image tone (p.110) |
| 6 | AF point information (p.124) | 19 | Contrast (p.113) |
| 7 | Shutter speed (p.136) | 20 | Quality level (p.112) |
| 8 | Aperture value (p.138) | 21 | Recorded pixels (p.111) |
| 9 | EV compensation (p.143) | 22 | Color space (p.119) |
| 10 | Saturation (p.113) | 23 | Lens focal length |
| 11 | Mode dial position (p.106) | 24 | White balance (p.114) |
| 12 | AE metering (p.132) | 25 | Captured date and time (p.166) |
| 13* | Flash mode (p.51) | 26* | Scene mode (p.47) |

* Indicator 13 only appears for images in which the flash was discharged.

Indicators 14 and 15 do not appear at the same time. Only one appears at a time. Indicator 26 is only displayed in Scene mode.

● Histogram Display

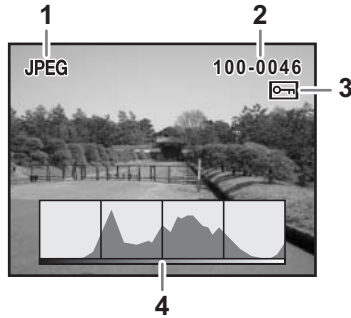

- 1 Capture quality (Image file type)
- 2 Image folder number and file number (p.172, p.173)
- 3 Protect icon (p.80)
- 4 Histogram (p.163)



- Areas where blooming overexposure occurred blink if [Bright Portion] warning is set to On in [Plybk dsply mthd] in the [▶ Playback] menu. (p.163)
- Press the four-way controller (⏪ ⏩) in the histogram display to move the histogram display position up or down.

Viewfinder Indications

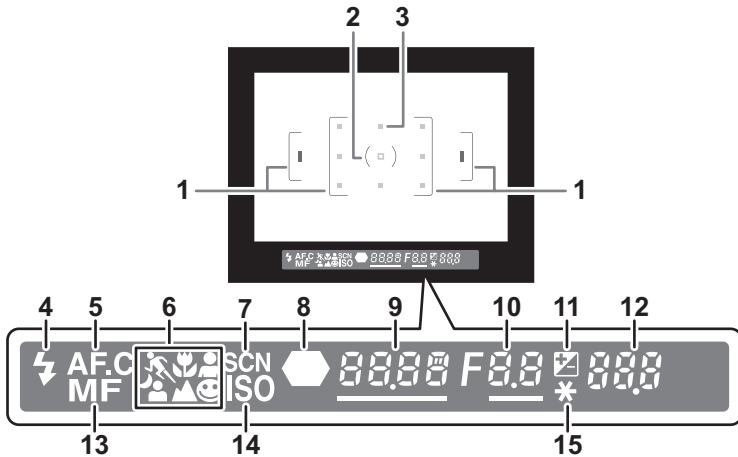

- 1 AF frame (p.39)
- 2 Spot metering frame (p.132)
- 3 AF point (p.124)
- 4 Flash status (p.51)
Appears when flash is available and blinks when flash is recommended but not set.
- 5 Continuous mode (p.123)
Appears when [AF Mode] in the [📷 Rec. Mode] is set to **A.F.C** (Continuous mode).
- 6 Picture mode icon (p.47)
Icon for Picture mode in use appears.
👤 (Moving Object), 🌿 (Macro), 👤 (Portrait), 😊 (Normal mode in **AUTO PICT**), 🌃 (Night Scene Portrait), 🏞️ (Landscape)
- 7 Scene mode icon (p.47)
Appears when taking pictures in Scene mode.
- 8 Focus indicator (p.44)
Appears when image is focused.
- 9 Shutter speed (p.136)/Confirm Sensitivity
Shutter speed when capturing or adjusting (underlined when shutter speed can be adjusted with e-dial).
The sensitivity is displayed when [OK btn when shooting] is set to [Confirm Sensitivity] and the **OK** button is pressed. (p.122)

- 10 Aperture value (p.138)
Aperture value when capturing or adjusting (underlined when aperture can be adjusted with e-dial).
- 11 EV compensation (p.143)
Appears when EV compensation is available or in use.
Blinks slowly when compensating flash output.
Blinks quickly when compensating exposure and flash output.
Adjusted value appears where number of recordable images is shown.
- 12 Number of recordable images/EV compensation
Show the number of recordable images with current quality and recorded pixel setting.
Show the number of continuous shooting recordable images. (p.102)
EV compensation value appears when EV compensation is being adjusted. (p.135)
The difference with the appropriate exposure value appears if exposure mode is **M**. (p.140)
- 13 Manual focus (p.128)
Appears when focus mode is **MF**.
- 14 ISO sensitivity warning (p.118)
Appears when warning value is exceeded.
- 15 AE lock indicator (p.144)
Appears during AE lock.



- The red indication of the AF point used for autofocus lightens superimposed when the shutter release button is pressed halfway. (p.124)
- When [OK btn when shooting] is set to [Confirm Sensitivity] in the [C Custom Setting] menu, press the **OK** button to display the sensitivity in the viewfinder. (p.122)

LCD Panel Indications

The following information appears in the LCD panel on top of the camera.

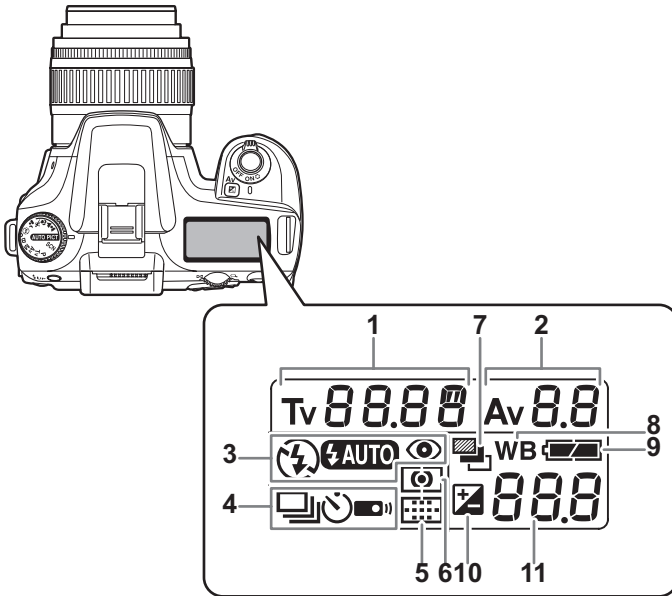

- | | |
|---|--|
| <p>1 Shutter speed (p.136)</p> <p>2 Aperture value (p.138)</p> <p>3 Flash mode (p.51)</p> <p>⚡ : Built-in flash is ready (when blinking, flash should be used or incompatible lens is being used)</p> <p>⊞ : Flash off</p> <p>⚡ AUTO : Auto discharge</p> <p>👁 : Red-eye reduction flash on</p> <p>4 Drive mode (p.104)</p> <p>□ : Single frame shooting</p> <p>📷 : Continuous shooting</p> <p>⌚ : Self-Timer shooting</p> <p>📡 : Remote control shooting</p> | <p>5 AF point information (p.124)</p> <p>No indicator: Auto</p> <p>⊞ : Select</p> <p>□ : Center</p> <p>6 AE metering (p.132)</p> <p>No indicator: Multi-segment metering</p> <p>👁 : Center-weighted metering</p> <p>□ : Spot metering</p> <p>7 Auto bracketing (p.147)</p> <p>8 White balance (p.114) (Not displayed when set to Auto)</p> <p>9 Battery level</p> <p>10 EV compensation (p.143)</p> <p>11 Number of recordable images/ EV compensation value/PC (Pb) (PC=Personal Computer (mass storage), Pb=PictBridge)</p> |
|---|--|

2 Getting Started

This chapter explains your first steps from purchasing the camera to taking pictures. Be sure to read it and follow the instructions.

| | |
|--|-----------|
| Attaching the Strap | 24 |
| Inserting the Batteries | 25 |
| Inserting/Removing the SD Memory Card | 29 |
| Turning the Camera On and Off | 32 |
| Initial Settings | 33 |
| Attaching the Lens | 37 |
| Adjusting the Viewfinder Diopter | 39 |

Attaching the Strap

- 1** Pass the end of the strap through the strap lug, then secure on the inside of the clasp.

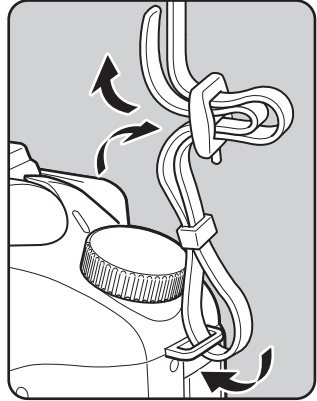

- 2** Pass the other end of the strap through the other strap lug on the camera, then secure on the inside of the clasp.

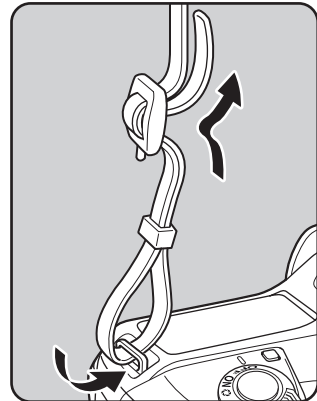

Insert batteries into the camera. Use two CR-V3 or four AA Ni-MH batteries, AA lithium batteries, or AA alkaline batteries.

This camera is packaged with AA alkaline batteries for checking the camera's functionality but some other kinds of batteries are also compatible. Refer to "Batteries" (p.26) for details on compatible batteries and when to use them.



- CR-V3, AA lithium batteries and AA alkaline batteries that can be used in this camera are not rechargeable.
- Do not open the battery cover or remove the batteries while the power is on.
- Remove the batteries when you will not use the camera for a long while. The batteries may leak.
- If the date and time settings have been reset when you insert new batteries after a long while, follow the procedure for "Setting the Date and Time". (p.35)
- Insert batteries correctly. Batteries inserted incorrectly may cause a camera breakdown. Wipe the electrodes of the batteries before inserting.
- Replace all the batteries at the same time. Do not mix battery type, brands or an old battery with a new one.

1

Push and hold the battery cover unlock lever as shown in the illustration (①), and slide the battery cover toward the lens (②), and then flip open.

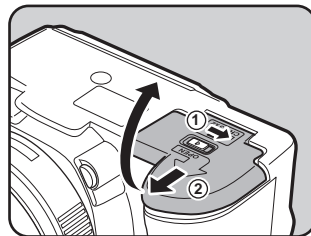
**2**

Insert the batteries according to the +/- indicators in the battery chamber.

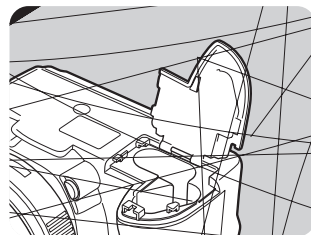

2

3

Press down on the batteries with the battery cover (①) and slide it as shown in the illustration (②) to close.

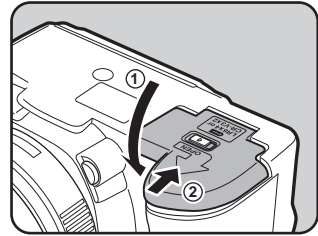

2

Getting Started



- Use the AC adapter (optional) when using the camera for a prolonged period. (p.28)
- Check the battery orientation if the camera does not operate properly after replacing the batteries.



Be sure to fully close the battery cover. The camera will not turn on if the battery cover is open.

Batteries

You can use four kinds of batteries with your camera. Battery performance differs by type. Please choose the type that best suits your purpose.

| | |
|---------------------------------|--|
| CR-V3* | The CR-V3 is a long-life battery and is convenient when traveling. |
| AA Ni-MH rechargeable batteries | These are rechargeable and are economical. A commercially available battery charger that is compatible with the batteries is required. |
| AA lithium batteries | Recommended in cold climates. |
| AA alkaline batteries | Provided with the camera. These are easily obtainable when your usual batteries run out but they may not support all the camera functions under certain conditions. We do not recommend their use except in emergencies and checking the camera's functionality. |





* CR-V3 batteries have rechargeable and non-rechargeable types. This camera uses only non-rechargeable CR-V3 batteries.



Nickel manganese batteries and rechargeable CR-V3 batteries may cause malfunctions due to their voltage characteristics. Therefore, use is not recommended.

Battery Level Indicator

You can confirm remaining battery level by checking the  displayed on the LCD panel.

| | | |
|---|-------|--|
|  | lit | : Battery is full. |
| ↓ | | |
|  | lit | : Battery is running low. |
| ↓ | | |
|  | lit | : Battery is almost empty. |
| ↓ | | |
|  | blink | : The camera turns off after displaying a message. |

Approximate Image Storage Capacity and Playback Time (new batteries)

| Batteries | (Temperature) | Normal recording | Flash photography | | Playback time |
|--|---------------|------------------|-------------------|----------------|---------------|
| | | | 50% use | 100% use | |
| CR-V3 | (23°C) | 730 | 630 | 480 | 700 minutes |
| | (0°C) | 300 | 210 | 180 | 470 minutes |
| AA lithium batteries | (23°C) | 660 | 570 | 450 | 470 minutes |
| | (0°C) | 520 | 360 | 310 | 400 minutes |
| AA rechargeable batteries (NiMH 2500mAh) | (23°C) | 430 | 300 | 260 | 350 minutes |
| | (0°C) | 350 | 250 | 200 | 300 minutes |
| AA Alkaline Batteries | (23°C) | 80 | 60 | 40 | 140 minutes |
| | (0°C) | Not applicable | Not applicable | Not applicable | 70 minutes |

The picture storage capacity (normal recording and flash use 50%) is based on measuring conditions in accordance with CIPA standards and the others are based on PENTAX measuring conditions. Some deviation from the above figures may occur in actual use depending on shooting mode and shooting conditions.



- Battery performance temporarily decreases as the temperature decreases. When using the camera in cold climates, have extra batteries on hand and keep them warm in your pocket. Battery performance will return to normal when returned to room temperature.
- AA alkaline batteries may not support all the camera functions. We do not recommend their use except in emergencies and checking the camera's functionality.
- Have extra batteries ready when traveling overseas, taking pictures in cold climates, or when you will be taking a lot of pictures.

Using the AC Adapter (Optional)

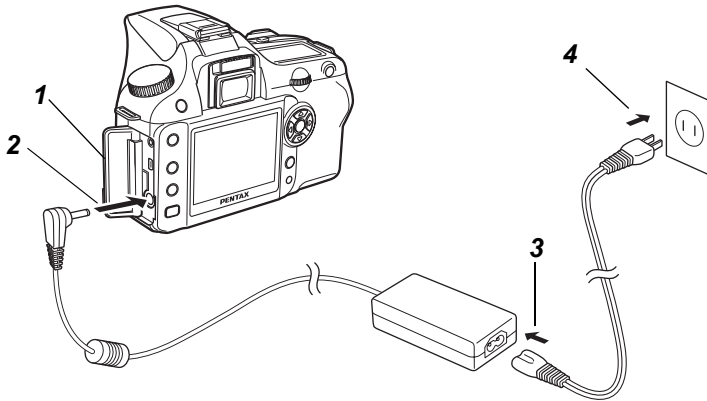

We recommend using the AC adapter kit K-AC10 (optional) when using the LCD monitor for a long time or when connecting to your PC.

- 1** Make sure the camera is turned off before opening the terminal cover.
- 2** Connect the DC terminal on the AC adapter to the DC input terminal on the camera.
- 3** Connect the AC plug cord to the AC adapter.
- 4** Plug the AC cord into the power outlet.



- Make sure the camera is turned off before connecting or disconnecting the AC adapter.
- Make sure connections are secure between the camera, AC adapter, AC plug cord terminal and the power outlet. SD Memory Card and data will be corrupted if disconnected while camera is recording or reading data.



- Be sure to read the AC adapter kit K-AC10 operating manual when using the AC adapter.
- The rechargeable batteries in your camera will not charge when connected to the AC adapter.

Inserting/Removing the SD Memory Card

Captured images are recorded on the SD Memory Card. Make sure the camera is turned off before inserting or removing the SD Memory Card (market product).



- Do not remove the SD Memory Card while card access lamp is lit.
- Format new SD Memory Card. Also format SD Memory Card used with other cameras. Refer to "Formatting the SD Memory Card" (p.165) for details on formatting.

1

Slide the card cover in the direction of the arrow (①) and then lift open (②).

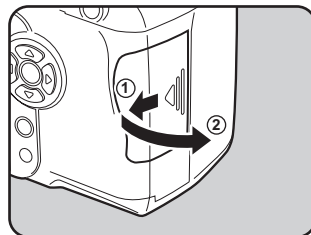
**2**

Insert the card all the way with the SD Memory Card label toward the LCD monitor.

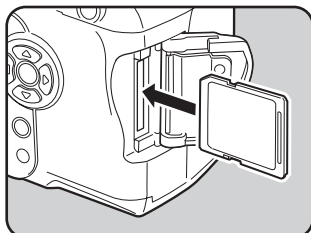

Push the SD Memory Card in once to remove.

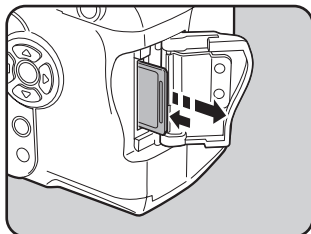
**3**

Close the card cover (①) and then slide it in the direction of the arrow (②).

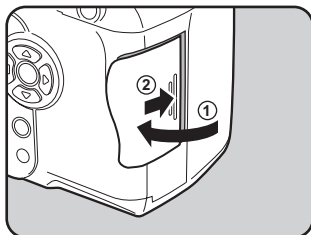

Be sure to fully close the card cover. The camera will not turn on if the card cover is open.

**2**

Precautions When Using the SD Memory Card

- The SD Memory Card is equipped with a write-protect switch. Setting the switch to LOCK protects the existing data by prohibiting recording of new data, deletion of existing data or formatting of the card.
- Care should be taken when removing the SD Memory Card immediately after using the camera because the card may be hot.
- Do not remove the SD Memory Card or turn the camera off while data is being saved to the card, images are being played back, or the camera is connected to a computer with the USB cable. This may cause the data to be lost or the card to be damaged.
- Do not bend the SD Memory Card or subject it to violent impact. Keep it away from water and store away from high temperatures.
- Do not remove the SD Memory Card during formatting. The card may be damaged beyond use.
- Data on the SD Memory Card may be deleted in the following circumstances. PENTAX does not accept any liability for data that is deleted if
 - (1) the SD Memory Card is mishandled by the user.
 - (2) the SD Memory Card is exposed to static electricity or electrical interference.
 - (3) the card has not been used for a long time.
 - (4) the card is ejected or the battery is removed while the data on the card is being recorded or accessed.
- The SD Memory Card has a limited service life. If it is not used for a long time, the data on the card may become unreadable. Be sure to regularly make a backup of important data on a computer.
- Avoid using or storing the card where it may be exposed to static electricity or electrical interference.
- Avoid using or storing the card in direct sunlight or where it may be exposed to rapid changes in temperature or to condensation.
- For information on compatible SD Memory Card, visit the PENTAX website or contact your nearest PENTAX customer service center.
- Format new SD Memory Cards. Also format SD Memory Card used with other cameras.  Formatting the SD Memory Card (p.165)
- If you are going to discard, give away or sell your SD memory card you should ensure that the data on the card is completely deleted or the card itself is destroyed if it contains any personal or sensitive information. Please note that formatting the SD card will not necessarily delete the data so that it cannot be recovered using off the shelf data recovery software. There are off the shelf secure data deletion software programs available that will completely delete the data. In any case the data on your SD memory card should be managed at your own risk.

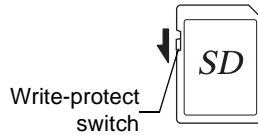

Recorded Pixels and Quality Level

Choose the number of pixels (size) and quality level (data compression rate) of pictures according to how you intend to use the pictures you have taken.

Pictures with larger recorded pixels or more ★s are clearer when printed. The number of pictures that can be taken (the number of pictures that can be recorded on an SD Memory Card) becomes less with larger file sizes. The quality of the captured photo or printed picture depends on the quality level, exposure control, resolution of the printer and a variety of other factors so you do not need to select more than the required number of pixels. For example, to print in postcard size, **1.5M** (1536×1024) is adequate. Set the appropriate recorded size and quality level depending on purpose.

Choose the appropriate number of recorded pixels and quality level for images on the [📷 Rec. Mode] menu.

- ☞ Setting the Recorded Pixels (p.111)
- ☞ Setting the Quality Level (p.112)

● Recorded Pixels, Quality Level and Approximate Image Storage Capacity

| Quality Level Recorded Pixels | | RAW | ★★★ Best | ★★ Better | ★ Good |
|----------------------------------|---|-----------------------|-------------|--------------|-----------|
| | | 6M (3008×2008) | 11 | — | — |
| (3008×2000) | — | 34 | 70 | 117 | |
| 4M (2400×1600) | — | 51 | 96 | 161 | |
| 1.5M (1536×1024) | — | 106 | 173 | 271 | |



- The above table shows the approximate image storage capacity and recording time when using a 128 MB SD Memory Card.
- The above figures may vary depending on the subject, shooting conditions, shooting mode and SD Memory Card, etc.

1 Move the main switch to [ON] position.

The camera will turn on.

Move the main switch to [OFF] position to turn off the camera.



- Always turn the camera off when not in use.
- The power will automatically turn off when you do not perform any operations within a set period of time. After the camera turns off automatically, turn it on again or perform any of the following.
 - Press the shutter release button halfway.
 - Press the  button.
 - Press the **INFO** button.
- By default, the camera is set to power off automatically after 1 minute of inactivity. You can change the setting with [Auto Power Off] on the [ Setup] menu. (p.172)

The first time the camera is turned on after purchasing, the Initial Settings screen appears on the LCD monitor. Follow the procedure below to set the language displayed on the LCD monitor and the current date and time. Once setting is done, these will not need to be set again when turning your camera on.

Setting the Display Language

You can choose the language in which the menus, error messages, etc. are displayed from the following: English, French, German, Spanish, Italian, Swedish, Dutch, Russian, Korean, Chinese (traditional/simplified) and Japanese.

- 1 Press the four-way controller (▶).**

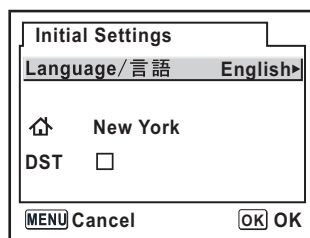

- 2 Use the four-way controller (◀▶) to select the desired language.**

The default setting is English.

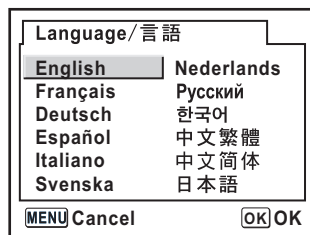

- 3 Press the OK button.**

4 Press the four-way controller () .

The cursor moves to [].

5 Press the four-way controller () to select the city.

6 Press the four-way controller () .

The cursor moves to DST (daylight saving time).

7 Use the four-way controller () to select (On) or (Off).

8 Press the OK button.

The screen for setting the date and time will be displayed.

When an Incorrect Language is Set

Follow the procedure below to display the screen for setting the language, and go to Step 2 on p.33 to set the language again.

1 Turn the camera off and turn it on again.

2 Press the MENU button.

3 Press the four-way controller () twice.

4 Press the four-way controller () five times.

5 Press the four-way controller () once.

The screen for setting the language will be displayed.

Setting the Date and Time

Set the current date and time and the display style.

- 1 Press the four-way controller (⬇️).

The frame moves to [mm/dd/yy].

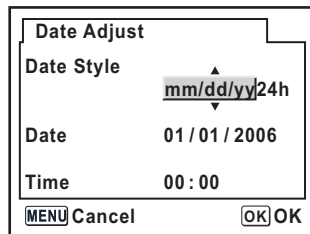

- 2 Use the four-way controller (⬅️ ⬆️) to choose the date style.

- 3 Press the four-way controller (⬇️).

The frame moves to [24h].

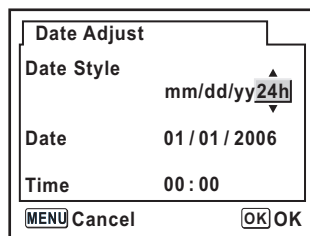

- 4 Use the four-way controller (⬅️ ⬆️) to select 24h (24-hour display) or 12h (12-hour display).

- 5 Press the four-way controller (⬇️).

The frame returns to [Date Style].

- 6 Press the four-way controller (⬆️).

The frame moves to [Date].

7 Press the four-way controller (▶).

The frame moves to the month.

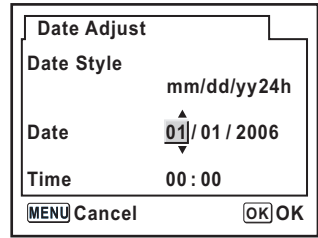

8 Use the four-way controller (◀▶) to set the month.

Set the day and year in the same manner.

Next, set the time.

If you select [12h] in Step 4, the setting switches between am and pm depending on the time.

9 Press the OK button.

The camera is ready to take pictures. If you set the date and time with the menu operations, the screen will return to the [X↓ Set-up] menu.

Press the **OK** button again.



You can cancel the setting operation and switch to Capture mode during initial settings by pressing the **MENU** button. In this case, the Initial Settings screen will appear again the next time you turn the camera on.



- When you finish the settings and press the **OK** button, the camera clock is reset to 00 seconds. To set the exact time, press the **OK** button when the time signal (on the TV, radio, etc.) reaches 00 seconds.
- You can change the language and date and time settings with the menu operations. (p.166, p.170)

All camera exposure modes are available when using DA, D FA, FA J or other lenses with Aperture **A** (Auto) position. Some functions are restricted when lenses are not set to Aperture **A** (Auto). Also see “Notes on [Using Aperture Ring]” (p.184). Other lenses and accessories will not be available with factory default settings. To allow shutter release with lenses or accessories not listed above, set [Using aperture ring] in custom function settings. (p.103)



Turn the camera off before attaching or removing the lens to prevent unexpected lens movement.

1 Check that the camera is off.

2 Remove the body mount cover (①) and lens mount cover (②).

Be sure to put the lens down with the lens mount side facing upward to protect from damage to the area around the lens mount after removal.

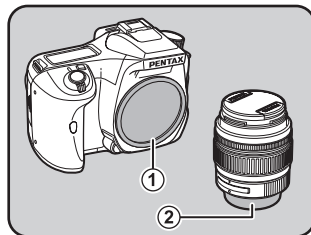

3 Align the red dots on the camera and the lens, and secure by turning the lens clockwise until it clicks.

After attaching, check that the lens is secured. Also check that the red dots of the lens are on top and attachment portion does not move sideways.

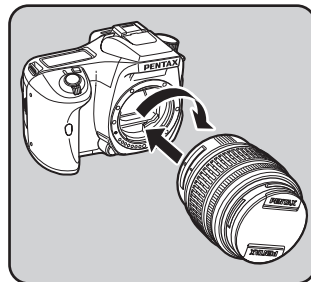

Adjust the viewfinder to suit your eyesight. If it is difficult to see the viewfinder image clearly, slide the diopter adjustment lever sideways.

You can slide the diopter from -2.5m^{-1} to $+1.5\text{m}^{-1}$.

1 Look through the viewfinder and point the camera at a well-lit scene. Slide the diopter adjustment lever left or right.

Adjust the lever until the AF frame in the viewfinder is focused.

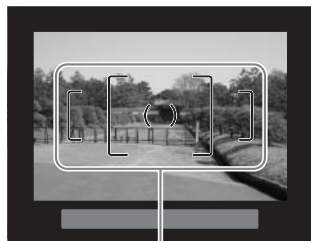
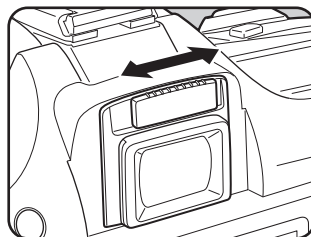

AF frame



- The Fo Eyecup is attached to the viewfinder portion when camera leaves the factory. Diopter adjustment is available with the Fo Eyecup attached. However, adjustment is easier with the eyecup removed. To remove the Fo Eyecup, press in one side and pull it out toward you.

To attach the Fo Eyecup, align it with the groove on the viewfinder eyepiece and push it into position.

- If it is difficult to see the viewfinder image clearly even if you set the diopter adjustment lever, use the diopter correction lens adapter M. However, the eyecup must be removed to use this adapter. (p.188)

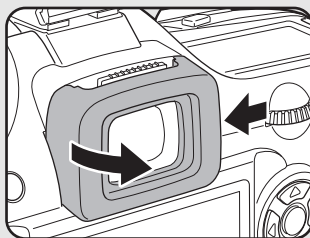

Memo

3 Basic Operations

This chapter explains basic operations for shooting by setting mode dial to Picture mode (Auto Picture or Portrait mode - Flash OFF mode) and Scene mode to ensure successful capturing.

For information about advanced functions and settings for taking pictures, refer to chapter 4 and onward.

| | |
|--|-----------|
| Basic Shooting Operation | 42 |
| Selecting the Appropriate Capturing Mode for Scenes | 47 |
| Using a Zoom Lens | 50 |
| Using the Built-in Flash | 51 |
| Other Shooting Modes | 55 |
| Playing Back Still Pictures | 65 |
| Connecting the Camera to AV Equipment | 72 |
| Processing Images with Filters | 73 |
| Deleting Images | 76 |
| Setting the Printing Service (DPOF) | 82 |
| Printing Using PictBridge | 85 |

Holding the Camera

How you hold the camera is important when taking pictures.

- Hold the camera firmly with both hands.
- Press the shutter release button gently when taking a picture.

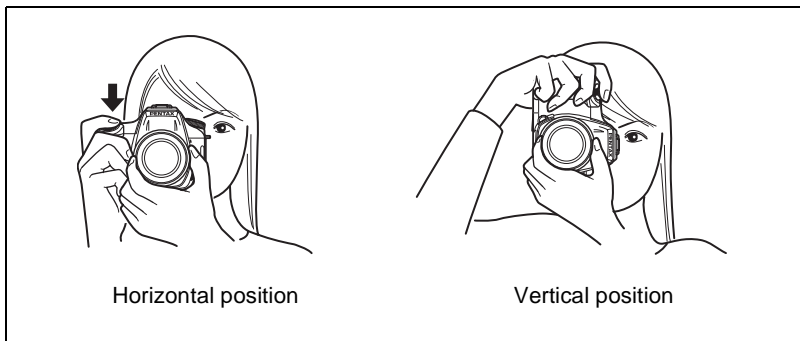

3

Basic Operations



- To reduce camera shake, support your body or the camera on a solid object such as a table, tree, or wall.
- Although there are individual differences among photographers, the shutter speed for a handheld camera is generally $1/(\text{focal length} \times 1.5)$. For example, it is $1/75$ of a second for a focal length of 50 mm and $1/150$ of a second for 100 mm. Use a tripod when using a lower shutter speed.
- When using a telephoto lens, a tripod that is heavier than the total weight of the camera and lens is recommended to avoid camera shake.

3 Look through the viewfinder to view the subject.

A zoom lens can be used to change the size of the subject in the viewfinder.

☞ Using a Zoom Lens (p.50)

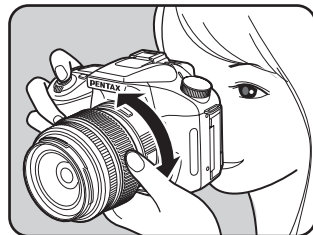

4 Position the subject inside the AF frame and press the shutter release button halfway.

The autofocus system operates. The focus indicator ● appears in the viewfinder when the subject is in focus.

The flash pops up automatically when necessary (manually lift the flash when Flash mode is not set to [Auto]).

☞ Operating the shutter release button (p.45)

☞ Subjects that are Difficult to Focus on (p.46)

☞ Using the Built-in Flash (p.51)

☞ Selecting the Focusing Area (AF Point) (p.124)

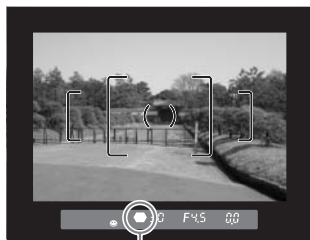

Focus indicator



You can preview the image in the LCD monitor and check the composition, exposure, and focus before taking the picture. (p.148)

5 Press the shutter release button fully.

The picture is taken.





Shutter release button

The shutter release button has two positions.

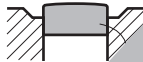

Pressing it down halfway (first

the autofocus system operates. Pressing it
takes the picture.

Press the shutter release button gently when taking a picture to prevent
shutter noise.

Press the shutter release button halfway to learn where the
focus position is.

The viewfinder indicators stay on while shutter release button is
pressed. The indications stay on for about 10 seconds (default setting)
after the button is released. (p.20)

No t p r e s s e d P r e s s e d h a l f w a y (f i r s t)

Subjects that are Difficult to Focus on

The autofocus mechanism is not perfect. Focusing may be difficult when taking pictures under the following conditions ((a) to (f) below). These also apply to manual focusing using the focus indicator ● in the viewfinder. If the subject cannot be focused automatically, set the focus mode lever to **MF** and use the manual focus mode to focus on the subject with the aid of the matte field in the viewfinder. (p.129)

- (a) Extremely low-contrast subjects such as a white wall in the focusing area.
- (b) Subjects which do not reflect much light within the focusing area.
- (c) Fast moving objects.
- (d) Strongly reflected light or strong backlighting (bright background).
- (e) If vertical or horizontal line patterns appear within the focusing area.
- (f) Multiple subjects in the foreground and background within the focusing area.



Subject may not be focused even when ● (focus indicator) is displayed when (f) above applies.

T
O

S
i
f
T
h
e
c
a
m
e
r
a
i
s
n
o
t
s
t
a
b
l
e

places, even if the built-in flash is used. To prevent camera shake, mount the camera on a tripod.

Scene

ndic

scenes. Use a tr

ring images of dazzling
mountains.

you take clear pictures of t
for capturing the sunrise or sun

For capturing moving kids.

Reproduces healthy and bright

For capturing moving pets.

For capturing scenes in candle

For capturing images in plac
prohibited.

s deactivated in  (Night Scene
useum) modes. To prevent c

3 Press the OK button.

The mode palette appears.

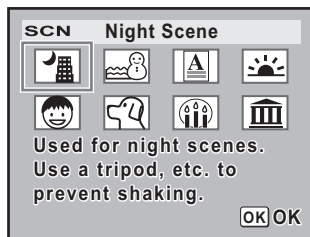

4 Use the four-way controller (◀▶) to choose a Scene mode.

If Pet mode is selected, you can turn the e-dial to choose a dog or a cat icon. The function is the same, regardless of which icon you choose.

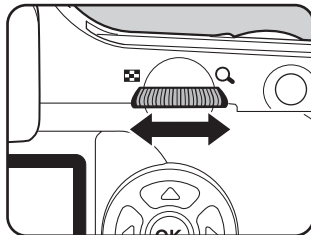

5 Press the OK button.

The screen returns to the Fn menu.

6 Press the Fn button.

The camera is ready to take a picture.

Enlarges the subject (telephoto) or captures a wider area (wide angle) with a zoom lens. Adjust it to the desired size and take the picture.

1 Turn the zoom ring to the right or left.

Turn the zoom ring clockwise for telephoto and counterclockwise for wide angle.



- The smaller the number of the displayed focal length, the wider the angle. The larger the number, the more magnified the image appears.
- Power Zoom functions (Image Size Tracking, Zoom Clip, and Auto Zoom Effect) are not compatible with this camera.

Use the following procedures to take a picture in low light or backlit conditions or when you want to manually use the built-in flash. The built-in flash is optimum at about 0.7 m to 4 m from the subject. Exposure will not be properly controlled and vignetting may occur when used at a distance closer than 0.7 m (this distance varies slightly depending on the lens being used and set sensitivity (p.152)).

Compatibility of built-in flash and lens

Vignetting (darkening of the corners of the image due to a lack of light) may occur depending on the lens being used and the capture conditions. We recommend taking a test shot to confirm this.

☞ DA, D FA , FA J, FA and F Lens Compatibility with the Built-in Flash (p.154)



- When using the built-in flash, remove the lens hood before shooting.
- The built-in flash fully discharges for lenses without a function to set aperture lens ring to **A** (Auto).

| | |
|--------------------------|---|
| AUTO Auto discharge | Camera automatically determines surrounding light and built-in flash pops up. The flash pops up and discharges automatically when necessary, such as when using a shutter speed likely to cause camera shake or in backlit conditions. (The flash may pop up but may not discharge if the camera determines that the flash is not necessary.) |
| MANUAL Manual discharge | Discharges flash manually. Flash discharges when popped up, does not discharge when retracted. |
| Auto flash+Redeye reduce | Lights a red-eye reduction light before automatic flash. |
| Manl flash+Redeye reduce | Discharges flash manually. Lights a red-eye reduction light before manual flash. |



Manual discharge mode (Flash ON) is used regardless of flash mode settings if the UP button is pressed to pop up the flash manually.

Selecting Flash Mode

1

Press the Fn button.

The Fn menu appears.

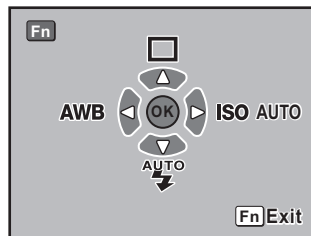

2 Press the four-way controller (◀▶).

The Flash options screen appears.



When the mode dial is set to **P**, **Tv**, **Av**, **M** or **B**, **AUTO** and **⚡** appear gray and cannot be selected.

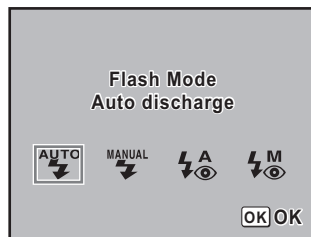

3 Use the four-way controller (◀▶) to choose a flash mode.

4 Press the OK button.

The camera returns to the Fn menu screen.

5 Press the Fn button.

The camera is ready to take a picture.

Using Auto Discharge **AUTO**, **⚡** (Automatic Flash Popup)

1 Set the mode dial to SCN, **AUTO PICT**, **🌃**, **🌇**, or **🏛️**.



The flash is deactivated when **🌃** (Night Scene), **🌇** (Sunset), **🏛️** (Candlelight) or **🏛️** (Museum) is selected in **SCN** (Scene) mode.

2 Press the shutter release button halfway.

The built-in flash pops up if necessary and begins charging. When the flash is fully charged, **⚡** appears in the LCD panel and viewfinder. (p.17, p.20, p.22)

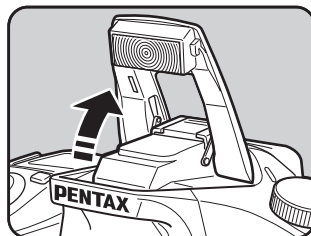

Switch between Auto discharge mode and Manual discharge mode (Flash ON) by pressing the **⚡UP** button while the built-in flash is popped up. If Auto discharge is set, **AUTO** appears on the LCD panel.

3 Press the shutter release button fully.

The picture is taken.

4 Push down on the portion indicated in the illustration to retract the flash.

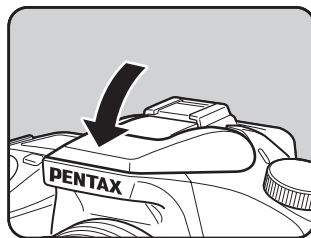

Using Manual Discharge (Flash ON) ^{MANUAL} ⚡, ⚡_M

1 Press the ^{UP} button.

The built-in flash pops up and begins charging. Manual discharge mode (Flash ON) is used regardless of flash mode settings. When the flash is fully charged, ^{MANUAL} ⚡ appears in the LCD panel and viewfinder. (p.17, p.20, p.22)

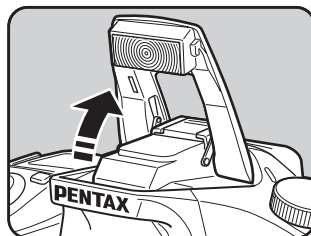
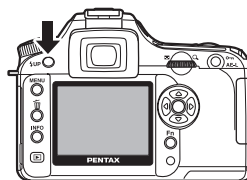

When Flash mode is set to ^{AUTO} ⚡ or ⚡_M and you pop up the built-in flash, you can switch between Auto discharge mode and Manual discharge mode (Flash ON) by pressing the ^{UP} button under the following conditions.

- Shooting mode is set to **AUTO PICT**, , , , , or .
- SCN mode is set to , , , or .

2 Press the shutter release button fully.

The flash discharges and the picture is taken.



3 Push the flash down to retract.

Using Red-eye Reduction Flash

“Red-eye” is the phenomenon where eyes look reddish in photographs taken in dark environments with a flash. This is caused by the reflection of the electronic flash in the retina of the eye. Red-eye occurs because pupils are dilated in dark environments.

This phenomenon cannot be averted but the following measures can be used to combat it.

- Brighten the surroundings when shooting.
- Set to wide angle and shoot from closer if a zoom lens is in use.
- Use a flash that supports red-eye reduction.
- Position the flash as far away from the camera as possible when using an external flash.

The red-eye reduction function on this camera reduces red-eye by discharging the flash twice. With the red-eye reduction function, the pre-flash is discharged just before the shutter is released. This reduces pupil dilation. The main flash is then discharged while the pupils are smaller, reducing the red-eye effect. To use the red-eye reduction function, set  (Red-eye reduction auto flash) in Picture mode or  (Red-eye reduction manual flash) in other modes for Flash mode.

Daylight-Sync Shooting

In daylight conditions, the flash will eliminate shadows when a portrait picture is taken with a person’s face cast in shadow. Use of the flash in this way is called Daylight-Sync Shooting. Flash is discharged manually when shooting with Daylight-Sync Shooting.

● Taking pictures (Auto Picture)

- 1 Confirm that the flash has popped up and the flash mode is set to  (Manual discharge). (p.53)
- 2 Confirm that the flash is fully charged.
- 3 Take the picture.



The picture may be overexposed if the background is too bright.



Without Daylight-Sync



With Daylight-Sync

Continuous Shooting

Pictures can be taken continuously while the shutter release button is held down.

- 1 Press the Fn button.

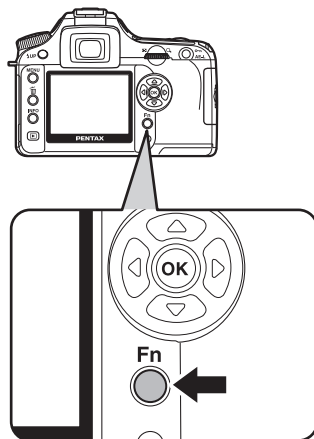

The Fn menu appears.

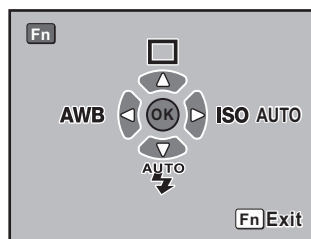

2 Press the four-way controller (▲).

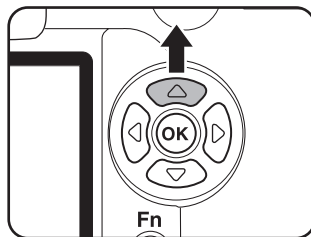

The Drive Mode options screen appears.

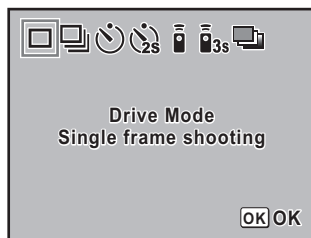

3 Use the four-way controller (▶) to select .

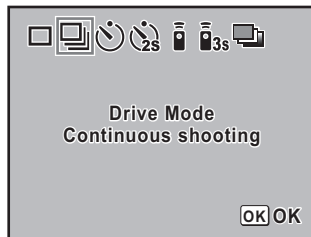

4 Press the OK button.

The camera returns to the Fn menu screen.

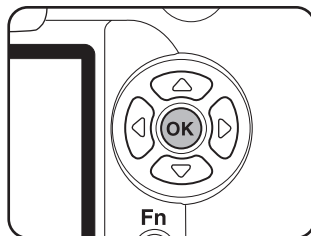

5 Press the Fn button.

The camera is ready to take pictures.

6 Press the shutter release button halfway.

The autofocus system operates. The focus indicator  appears in the viewfinder when the subject is in focus.



Set [No. cnt shtng rcd im] in [Recordable Image No.] of the [C Custom Setting] menu. The number of continuously recordable images (buffer space) appears when shutter is pressed halfway. (p.102)

7 Press the shutter release button fully.

Pictures are taken continuously while the shutter release button is fully pressed. Take your finger off the shutter release button to stop.

Continuous shooting settings are retained when the power is turned off. Display the Fn menu again and set to □ (Single frame shooting) to stop Continuous shooting.



- The focus is adjusted each time the shutter is released if the [AF Mode] in the [📷 Rec. Mode] is set to **A.F.S** (Single mode). (p.123)
- Focusing is continuously active when the mode dial is set to **P**, **Tv**, **Av** or **M** and [AF Mode] in the [📷 Rec. Mode] is set to **A.F.C** (Continuous mode), when Picture mode is set to 🐾 (Moving Object) or **SCN** mode is set to 👶 (Kids) or 🐾 (Pet). Note that the shutter will release even if the focusing is not complete.
- The shutter cannot be released until charging is complete when using the built-in flash. Use a custom function to enable shutter release before the built-in flash is ready. (p.151)

Self-Timer Shooting

This camera has two types of self-timers: ⌚ and 📷.

| | |
|---|--|
| ⌚ | Shutter will be released after about 12 seconds. Use this mode to include the photographer in the picture. |
| 📷 | A mirror pops up immediately after shutter release button is pressed. Shutter is released after about 2 seconds. Use this mode to avoid camera shake when the shutter release button is pressed. |

1 Mount the camera onto a tripod.

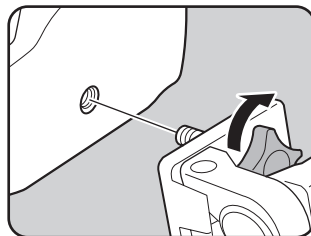

2 Press the Fn button.

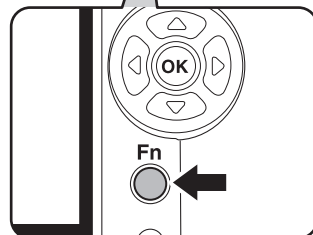
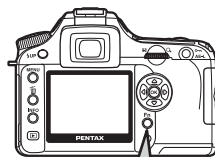

The Fn menu appears.

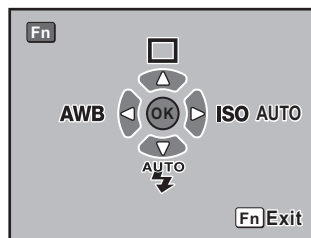

3 Press the four-way controller (▲).

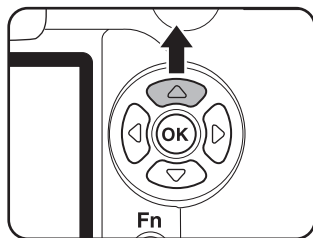

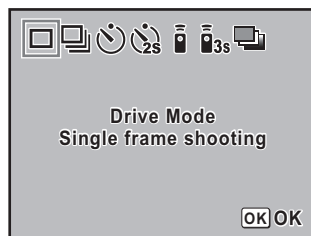

The Drive Mode options screen appears.

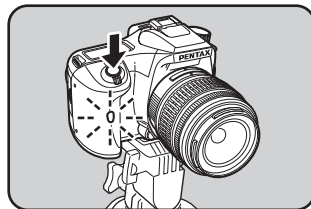

8 Press the shutter release button fully.

For , the self-timer lamp starts blinking slowly and blinks rapidly 2 seconds before the shutter is released. The beep is heard and the rate increases. The shutter will be released about 12 seconds after the shutter release button is pressed fully.



For , the shutter will be released about 2 seconds after the shutter release button is pressed fully.



- The beep can be turned off (p.166).
- Exposure may be affected if light enters the viewfinder. Attach the provided ME viewfinder cap or use the AE lock function (p.144). (Ignore the light entering the viewfinder when the exposure mode is set to **M** (Manual) (p.140).)
- To attach accessories such as the ME Viewfinder Cap, first remove the Fo Eyecup by pressing in one side and then pulling it out toward you.



9 Turn the camera off after shooting.

The next time the power is turned on, self-timer shooting is canceled and returns to single frame shooting.

3 Press the four-way controller (▲).

The Drive Mode options screen appears.

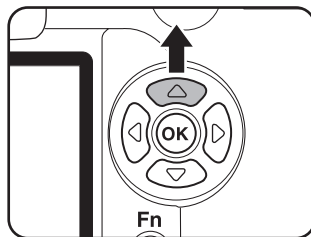

4 Use the four-way controller (◀▶) to select \bar{i} or \bar{i}_{3s} .

The self-timer lamp will blink to let you know that the camera is in remote control wait status.



5 Press the OK button.

The camera returns to the Fn menu screen.

6 Press the Fn button.

The camera is ready to take pictures.

7 Press the shutter release button halfway.

The autofocus system operates. The focus indicator ● appears in the viewfinder when the subject is in focus.



- You cannot focus with the remote control unit in default settings. Focus on the subject first before operating with the remote control. You can set [AF in remote control] to [On] in the custom function. (p.103)
- When using the remote control unit, flash does not pop up automatically even when set to AUTO (Auto discharge). Pop up the flash manually beforehand. (p.53)

Using Mirror Up Function to Prevent Camera Shake

Use the Mirror Up function if camera shake is evident even when cable switch (optional) or remote control unit (optional) is used.



When shooting with the 2 sec. Self-Timer, the mirror pops up and the shutter is released 2 seconds after you press it, thereby avoiding the vibration of the mirror.

Follow the procedure below to take a picture with the Mirror Up function.

3

Basic Operations

1 Mount the camera onto a tripod.

2 Use the Fn button and the four-way controller () to select  (2 sec. Self-Timer).

 Self-Timer Shooting (p.57)

3 Focus on the subject.

4 Press the shutter release button fully.

The mirror pops up and the picture is taken 2 seconds later. AE lock is enabled with the exposure value set immediately before the mirror goes up.

Playing Back Images

You can play back captured still pictures with the camera.



Use the included "PENTAX PHOTO Browser 3" software to play back using a PC. Refer to the "PENTAX PHOTO Browser 3/PENTAX PHOTO Laboratory 3 Operating Manual" for details.

1 Press the button after taking a picture.

The most recently captured image (image with the largest file number) is displayed on the LCD monitor.

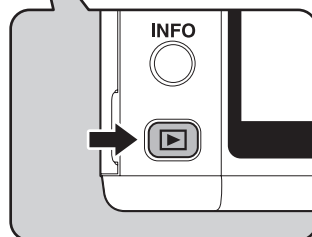
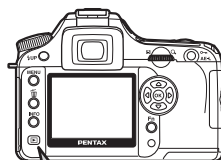

2 Press the four-way controller (◀▶).

- ◀ : The previous image appears.
- ▶ : The next image appears.

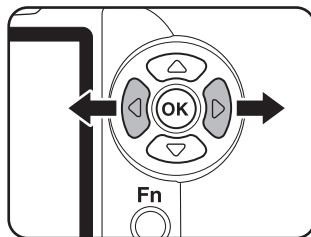

Rotating Images

You can rotate images 90° counterclockwise at a time. Make images shot vertically easier to view.



1 Press the ▶ button after taking a picture.

The most recently captured image (image with the largest file number) is displayed on the LCD monitor.

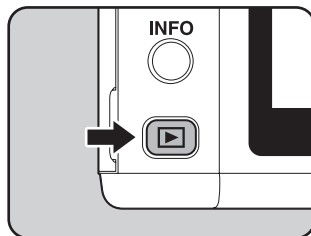

2 Press the four-way controller (⤵).

The image is rotated 90° counterclockwise each time the button is pressed.

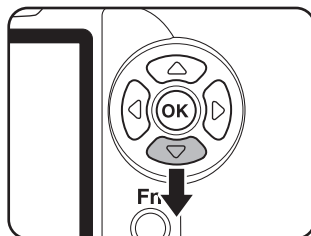



2 Turn the e-dial to the right (toward Q).

Image enlarges at each click and can be enlarged to 12 times the original. Turn to the left (toward ) to return. Press the **OK** button to return to the original size.

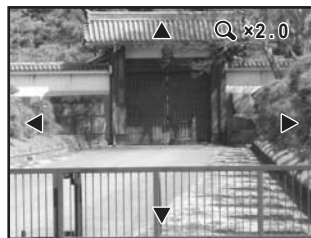

To return the magnified view of [Histogram] Display, [Detailed Information] Display and [No info. Display] (image only) to its original size, press the **OK** button.

To switch to [No info. Display] in magnified view, press the **INFO** button. To change the display area, press the four-way controller () in magnified view.



The default setting for the first click on the e-dial is 1.2 times. You can change this in [Mag to Strt Zm Plybk] in [C Custom Setting] menu. (p.103)

Nine-Image Display

You can display nine images on the LCD monitor at the same time.

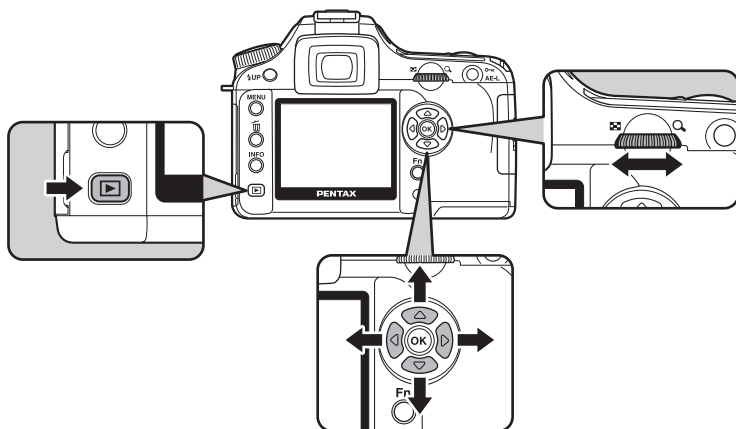





1 Press the button.

The most recently captured image (image with the largest file number) is displayed on the LCD monitor.



2 Turn the e-dial to the left (toward).

Up to nine thumbnail images will be displayed at once. Use the four-way controller (   ) to select an image. A scroll bar appears at the right of the screen. With an image selected in the bottom row, pressing the four-way controller () displays the next nine images.

[?] appears for an image that cannot be displayed.

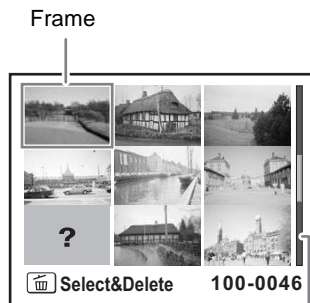

Scroll bar

3 Turn the e-dial to the right (towards) or press the OK button.

A full screen display of the selected image appears.



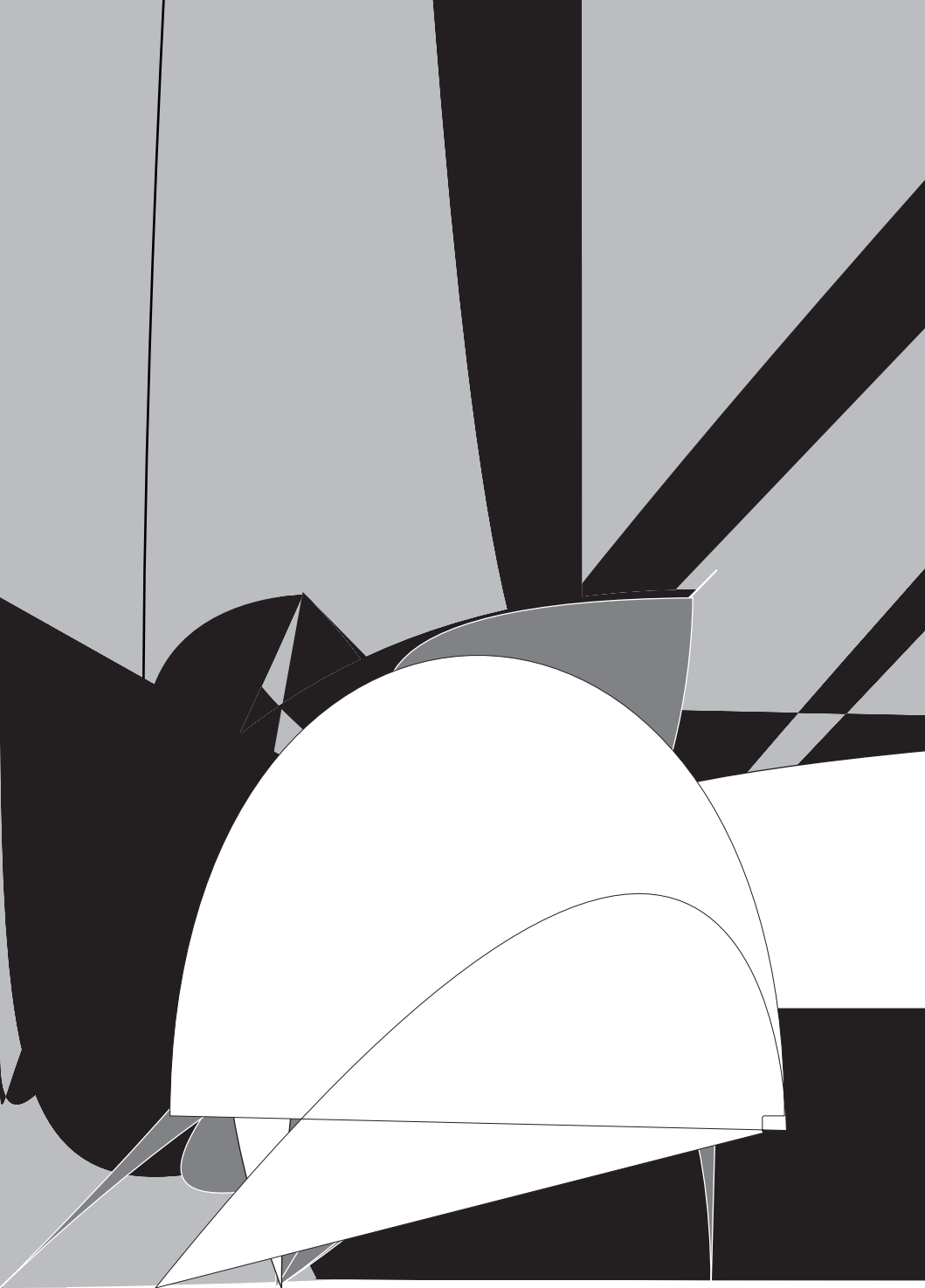





3 Press the four-way controller (⏪).

Start screen is displayed and slideshow begins.

Press any button to end slideshow.

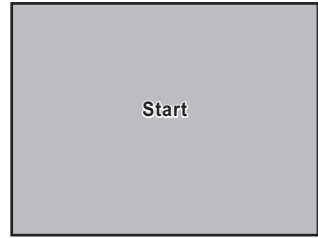
Press the shutter release button or the  button, slide the main switch to the preview position () or turn the mode dial to change to Capture mode.



Set the display time for slideshow in the [ Playback] menu. Alternatively, start the slideshow from the [ Playback] menu. (p.164)

Connecting the Camera to AV Equipment

By using the video cable, you can play back images using a TV or other device with a video IN jack as your monitor. Make sure that both the TV and the camera are turned off before connecting the cable.

☞ Selecting the Video Output Format (p.171)

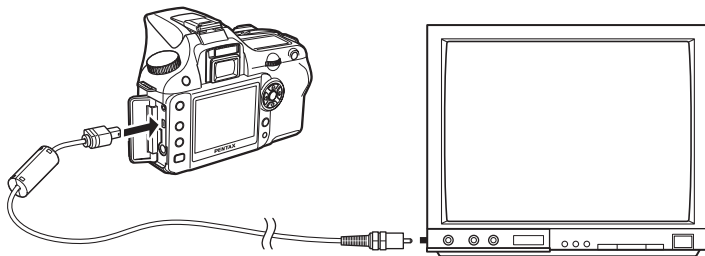

1 Open the terminal cover and connect the video cable to the USB/Video terminal.

2 Connect the other end of the video cable to the video IN jack on the AV device.

3 Turn the AV device and camera on.



- If you intend to use the camera continuously for a long period, use of the AC adapter (optional) is recommended. (p.28)
- For AV equipment with multiple video IN jacks (such as TVs), check the operating manual of the AV device, and select the video IN jack to which the camera is connected.
- Depending on the country or region, images may fail to be played back if the video output format is set different from the one in use there. If this happens, change the video output format setting. (p.171)
- The camera LCD monitor turns off while the camera is connected to the AV device.

You can edit shot images using digital filters. Processed images are saved under a different name.



- RAW images cannot be processed using the digital filter.
- Additionally, set digital filters from the [▶ Playback] menu.

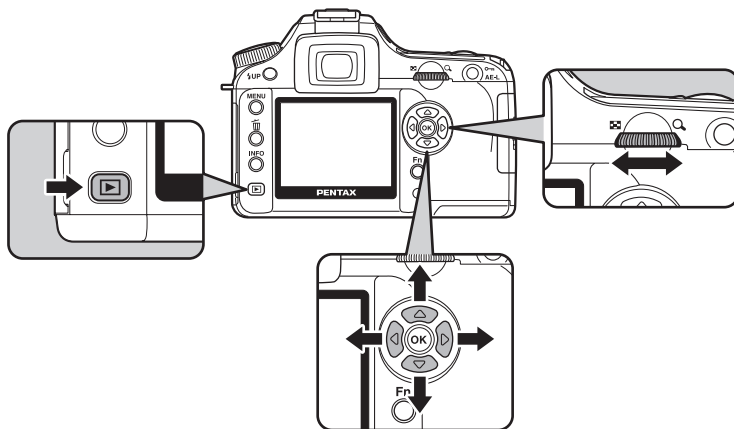

Digital Filter

| | |
|------------|---|
| B&W | Converts to a black and white image. |
| Sepia | Adds a vintage touch to photos by converting them to sepia color. |
| Color | Adds a color filter to the image. Selects from 18 filters (9 colors x 2 tones). |
| Soft | Creates a soft image by lightly fading the entire image. Selects from three levels. |
| Slim | Changes the horizontal and vertical ratio of images. Adjusts height or width up to two times the original size. |
| Brightness | Changes the brightness of images. Adjusts in a range of ± 8 levels. |

1 Press the Fn button in Playback mode.

The Fn menu appears.

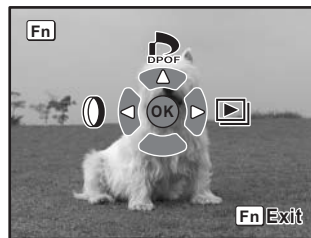

2 Press the four-way controller (⬅️).

The screen for selecting the filter appears.



3 Use the four-way controller (⬅️) to select an image.

4 Use the four-way controller (⬅️) to select a filter.

Select a filter and preview the effects on the image. Proceed to Step 5 if [Color] is selected. Proceed to Step 7 if [B&W] or [Sepia] is selected.

5 If [Color] is selected, turn the e-dial to select the filter color.

Select from 18 color filters: 9 basic colors (red, orange, yellow, yellow-green, green, cyan, blue, indigo and purple) and the same 9 colors with a darker hue.



6 Adjust with e-dial if slim filter, soft filter or brightness filter is selected.

Turn counterclockwise for wider and clockwise for slimmer if slim filter is selected. Turn counterclockwise to darken and clockwise to brighten if brightness filter is selected. Select softness from three levels if soft filter is selected.

Use the four-way controller (⏮⏭) to select an image. The image appears in the set slimness or softness.

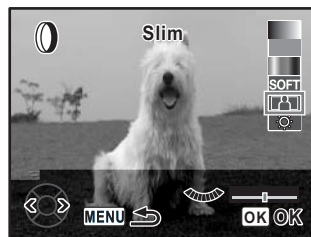

7 Press the OK button.

The save confirmation screen appears.

8 Use the four-way controller (⏮⏭) to select [Save as].



9 Press the OK button.

The filtered image is saved under a different name.

Deleting a Single Image

You can delete one image at a time.



- Deleted images cannot be restored.
- Protected images cannot be deleted.

3

Basic Operations

- 1 Press the button and use the four-way controller () to select an image to delete.



- 2 Press the button.
The Delete screen appears.

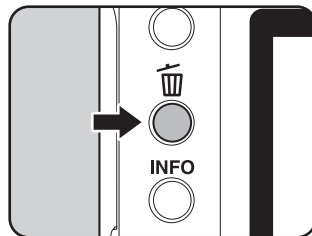

- 3 Use the four-way controller () to select [Delete].



- 4 Press the OK button.

The image is deleted.

Deleting All Images

You can delete all saved images at once.



- Deleted images cannot be restored.
- Protected images cannot be deleted.

1 Press the button.

2 Press the button twice.

The Delete All screen appears.

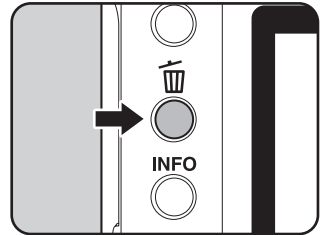

3 Use the four-way controller () to select [Delete All].



4 Press the **OK** button.

All images are deleted.

Deleting Selected Images (from Nine-Image Display)

You can delete multiple images from the nine-image display at once.



- Deleted images cannot be restored.
- Protected images cannot be deleted.
- Only files in the same folder can be selected at once.

3

Basic Operations

1 Press the button.

The most recently captured image (image with the largest file number) is displayed first on the LCD monitor.



2 Turn the e-dial to the left (toward).

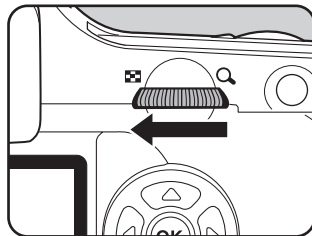

Nine thumbnail images appear.



3 Press the button.

appears on the images.

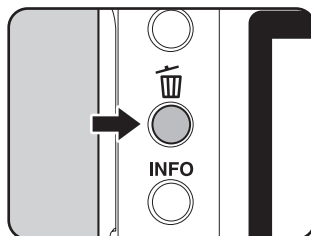

4 Use the four-way controller (, , ,) to move to the images to delete and press the OK button.

Image is selected and appears.

Press **Fn** button to select all images (the selection of images may take time to complete depending on the number of images).

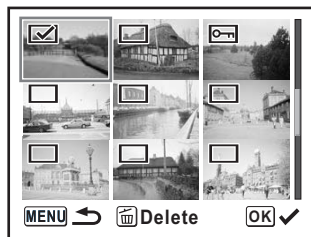

5 Press the button.

The Delete confirmation screen appears.

6 Use the four-way controller () to select [Select&Delete].

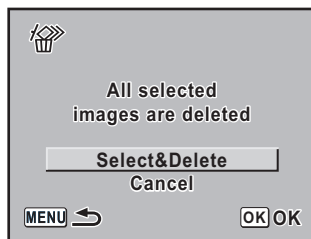

7 Press the OK button.

The selected images are deleted.

Protecting Images from Deletion (Protect)

You can protect images from being accidentally deleted.



Even protected images are deleted if the SD Memory Card is formatted.

- 1** Press the button and use the four-way controller () to select an image.

The most recently captured image (image with the largest file number) is displayed first on the LCD monitor.



- 2** Press the button.

The Protect screen appears.

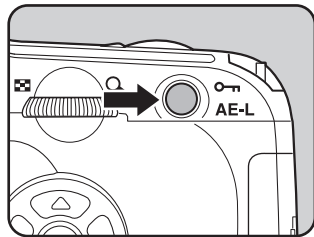

- 3** Use the four-way controller () to select [Protect].





- 4** Press the **OK** button.

The selected image is protected.





- Select [Unprotect] in Step 3 to cancel the Protect setting.
- The symbol is displayed when playing back protected images. (p.19)

Protecting All Images

- 1 Press the  button.
- 2 Press the  button twice.

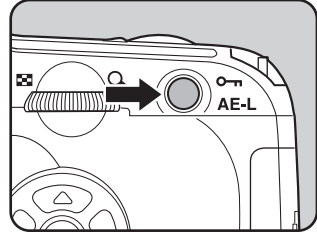
The Protect all images screen appears.



- 3 Press the four-way controller () to select [Protect] and press the OK button.

All images saved in the SD Memory Card are protected.



Select [Unprotect] in Step 3 to cancel the Protect setting on all of the images.

Setting the Printing Service (DPOF)

You can order conventional photograph prints by taking the SD Memory Card with recorded images to a store for a printing service.

DPOF (Digital Print Order Format) settings allow you to specify the number of copies or to imprint the date.



DPOF settings cannot be applied to RAW images.

3

Basic Operations

Printing Single Images

Set the following items for each image.

| | |
|--------|---|
| Copies | Selects the number of copies. You can print up to 99 copies. |
| Date | Specifies whether you want the date inserted on the print or not. |

1 Press the button and use the four-way controller () to select an image.

2 Press the Fn button.

The Fn menu appears.

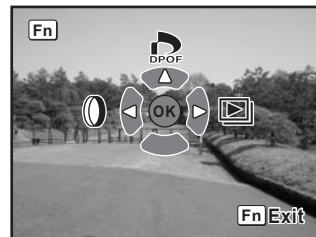

3 Press the four-way controller () .

The DPOF screen appears.

If DPOF settings have already been made for an image, the previous number of prints and date setting ((on) or (off)) will be displayed.



- 4** Use the four-way controller (◀▶) to choose the number of copies and press the four-way controller (⏏).

The frame moves to [Date].

- 5** Use the four-way controller (◀▶) to choose whether to insert the date (☑) or not (☐).

- ☑ : The date will be imprinted.
 ☐ : The date will not be imprinted.



- 6** Press the **OK** button.

The DPOF settings are saved and the camera returns to playback status.



Depending on the printer or printing equipment at the photo processing lab, the date may not be imprinted on the pictures even if the DPOF setting was made.



To cancel DPOF settings, set the number of copies to [00] in Step 4 and press the **OK** button.

Settings for All Images

- 1** Press the **Fn** button in Playback mode.

The Fn menu appears.

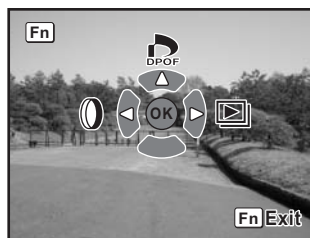

2 Press the four-way controller (▲).

The DPOF screen appears.



3 Press the Fn button.

The screen for making DPOF settings for all images appears.

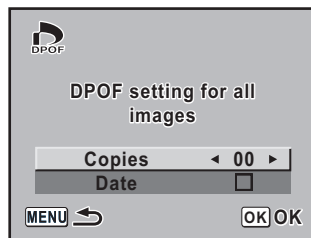

4 Use the four-way controller (◀▶) to choose the number of copies and whether to insert the date (☑) or not (☐).

Refer to Steps 4 and 5 of “Printing Single Images” (p.83) for details of how to make the settings.

5 Press the OK button.

The DPOF settings for all the images are saved and the camera returns to playback status.



The number of copies specified in settings for all images applies to all the images. Before printing, check that the number is correct.



Settings for single images are canceled when settings are made for all images.

This function lets you print images directly from the camera without using a PC (direct printing).

Connect the camera and PictBridge compatible printer with the included USB cable (I-USB17) to print directly.

Select the images you want to print, the number of copies and whether to insert the date or not on the camera after connecting to the printer.

Direct printing is performed in the following steps.

Set [Transfer Mode] on camera to [PictBridge] (p.86)



Connect the camera to the printer (p.87)



Set the printing options (p.82)

Print single images (p.88)

Print all images (p.90)

Print with DPOF settings (p.92)



- Use of the AC adapter is recommended when connecting the camera to a printer. The printer may not work properly or the image data may be lost if the batteries run out of power while the camera is connected to the printer.
- Do not disconnect the USB cable during data transfer.
- Depending on the type of printer, not all the settings made on the camera (such as print settings and DPOF settings) may be valid.
- A printing error may occur if the selected number of copies exceeds 500.
- Printing an index of images, where multiple images appear on a single sheet, may not be possible unless the printer supports index printing. For index prints, you may need to use a PC.
- RAW images cannot be printed directly. Use a PC to print RAW images.
- See the “PENTAX PHOTO Browser 3/PENTAX PHOTO Laboratory 3 Operating Manual” when connecting to a PC.

Setting [Transfer Mode]

1 Press the MENU button.

The [📷 Rec. Mode] menu appears.

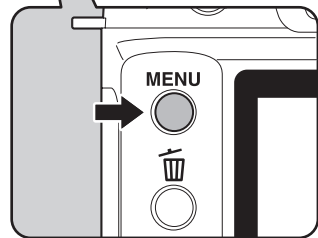
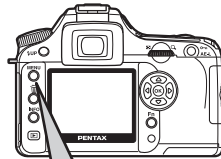

2 Use the four-way controller (⬅️➡️) to select the [X Set-up] menu.

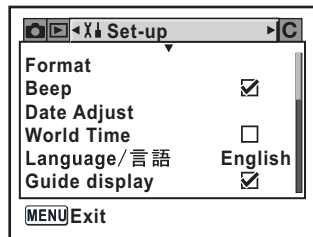

3 Use the four-way controller (⬅️➡️) to select [Transfer Mode].

4 Press the four-way controller (⬅️➡️).

A pop-up menu appears.

- 5** Use the four-way controller (▲▼) to select [Picture Bridge].

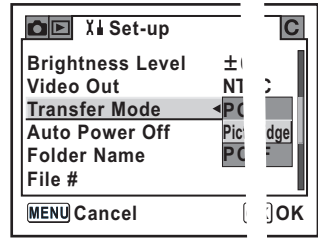

- 6** Press the **OK** button.
The setting is changed.

- 7** Press the **MENU** button.

Connecting the Camera to the Printer

- 1** Turn the camera off.
- 2** Connect the camera and printer using the USB cable supplied with the camera.
The PictBridge logo is displayed on the printer.

Connect a PictBridge compatible printer with the camera.

PictBridge compatible printers

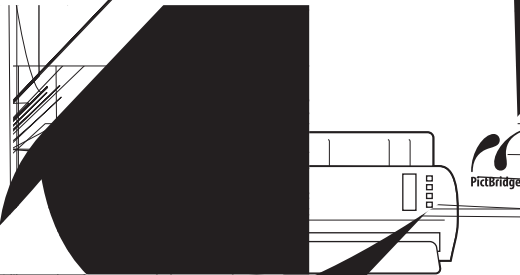

3 Turn the printer on.

4 After printer start-up is complete, turn the camera on.

The PictBridge menu appears.

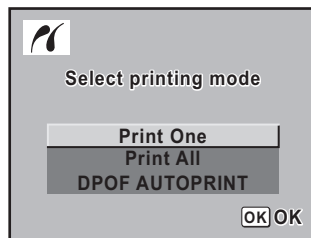

PictBridge menu is not displayed if [Transfer Mode] is set to [PC] or [PC-F].

3

Basic Operations

Printing Single Images

1 Use the four-way controller (⬅️⬆️⬇️⬅️) to select [Print One] on the PictBridge menu.

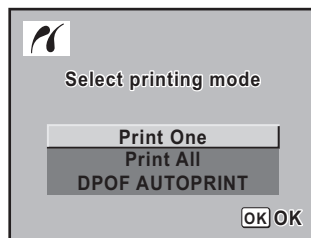

2 Press the OK button.

The Print One screen appears.

3 Use the four-way controller (⬅️⬆️⬇️⬅️) to choose an image to print.



4 Use the four-way controller (▲▼) to choose the number of copies.

You can print up to 99 copies.

5 Use the Fn button to choose whether to insert the date (☑) or not (☐).

☑ : The date will be printed.

☐ : The date will not be printed.

6 Press the OK button.

The print settings confirmation screen appears.

Proceed to Step 12 to print the images by default.

To change the print settings, go to Step 7.

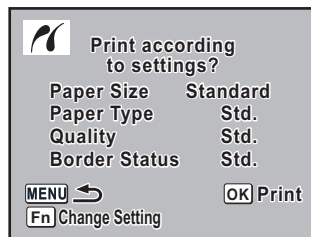

7 Press the Fn button.

The screen for changing print settings appears.

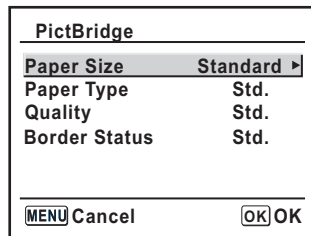

8 Select [Paper Size] and press the four-way controller (▶).

The Paper Size screen appears.

9 Use the four-way controller (▲▼◀▶) to choose the paper size.

You can only choose a size that is supported by your printer.

When the [Paper Size] is set to [Standard], images are printed according to the printer settings.

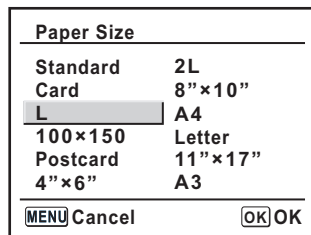

10 Press the **OK** button.

11 Repeat Steps 8 to 10 to set **[Paper Type]**, **[Quality]** and **[Border Status]**.

The print settings change screen appears after each item has been set. When [Std.] is selected for these print settings, images are printed according to the printer settings.

[Paper Type] with more ★s supports higher quality paper.

[Quality] with more ★s indicates higher print quality.

12 Press the **OK** button twice.

The image is printed according to the settings.

Press the **MENU** button to cancel printing.

Printing All Images

1 Use the four-way controller (⬅️⬆️⬇️⬅️) to select **[Print All]** on the PictBridge menu.

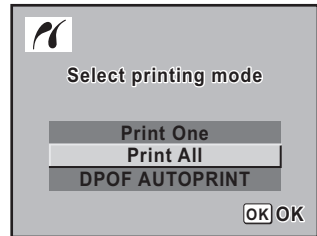

2 Press the **OK** button.

The Print all images screen appears.

3 Choose the number of copies and whether to imprint the date or not.

The number of copies and the date setting that you choose apply to all of the images.

Refer to Steps 4 and 5 of “Printing Single Images” (p.89) for details on how to make the settings.

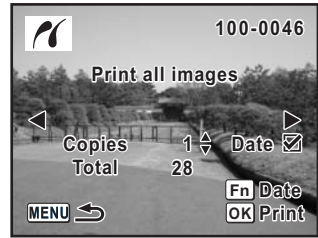

4 Press the OK button.

The print settings confirmation screen appears.

Refer to Steps 7 and 11 of “Printing Single Images” (p.89 and 90) for details on how to change the settings.

5 Press the OK button on the print settings confirmation screen.

All the images are printed according to the settings.

Press the **MENU** button to cancel printing.

Printing Images Using the DPOF Settings

1 Use the four-way controller (⬅️⬆️⬇️⬅️) to select [DPOF AUTOPRINT] on the PictBridge menu.

2 Press the **OK** button.

The Print w/DPOF settings screen appears. Use the four-way controller (⬅️⬆️⬇️⬅️) to check the number of copies for each image, whether the date is imprinted or not, and total number of copies. Print settings are set with the Print Service. (p.82)

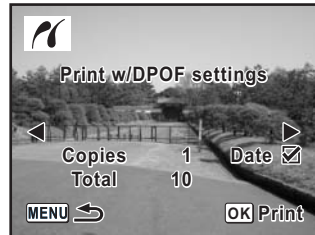

3 Press the **OK** button.

The print settings confirmation screen appears.

Refer to Steps 7 and 11 of “Printing Single Images” (p.89 and 90) for details on how to change the settings.

4 Press the **OK** button on the print settings confirmation screen.

The images are printed according to the settings.

Press the **MENU** button to cancel printing.

Disconnecting the USB Cable

Disconnect the USB cable from the camera and printer when you have finished printing.

1 Turn off the camera.

2 Disconnect the USB cable from the camera and printer.

4 Menu Reference

Explains the functions of *K110D* by buttons and menus.

| | |
|---|------------|
| Using the Button Functions | 94 |
| Using the Menu | 98 |
| Using the Fn Menu | 104 |
| Using the Mode Dial | 106 |

| |
|---|
| <p>When using menus and Fn menu, items which cannot be changed due to camera settings appear gray and cannot be selected.</p> |
|---|

Capture Mode

Functions of buttons used during shooting are noted.

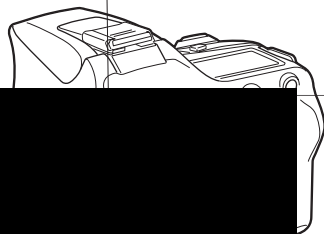
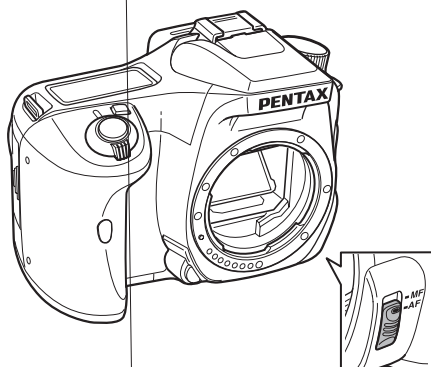

- ④ **Focus mode lever**
Switches between autofocus mode (p.120) and manual focus mode (p.128).
- ⑤ **Mode dial**
Changes the Shooting mode. (p.106)
- ⑥ **⚡UP button**
Press to pop up the built-in flash. (p.51)
- ⑦ **MENU button**
Displays the [📷 Rec. Mode] menu (p.100). Next, press the four-way controller (⬆️) to display [▶ Playback] menu (p.100), [X⬇️ Set-up] menu (p.101) and [C Custom Setting] menu. (p.102)
- ⑧ **INFO button**
Press to show shooting information on the LCD monitor. (p.17)
- ⑨ **▶ button**
Switches to the Playback mode. (p.65)
- ⑩ **📷Av button**
Press to set aperture and EV compensation values. (p.138, p.143)
- ⑪ **AE-L button**
Locks the exposure before shooting. (p.144)
Automatically adjusts the appropriate exposure in **M** (Manual) mode. (p.142)
- ⑫ **e-dial**
Sets shutter speed, aperture, and EV compensation values. (p.136, p.138, p.143)
- ⑬ **OK button**
Saves the setting you selected in the menu.
- ⑭ **Four-way controller** (⬆️ ⬇️ ⬅️ ➡️)
Use this to move cursor or change items in menus and Fn menu.
- ⑮ **Fn button**
Press to display the Fn menu. Press the four-way controller (⬆️ ⬇️ ⬅️ ➡️) to determine the following operation. (p.104)

⑤ INFO button

Press to show shooting information on the LCD monitor. (p.18)

⑥  button

Press to switch to Capture mode.

⑦  button

Press to protect images from being accidentally erased. (p.80)

⑧ e-dial

Use this to enlarge an image (p.67) or display nine images at the same time (p.68).





⑨ OK button

Saves the setting you selected in the menu or playback screen.

⑩ Four-way controller (   )

Use this to move cursor or change items in menus, Fn menu and playback screen.

⑪ Fn button

Press to display the Fn menu. Press the four-way controller (   ) to determine the following operation. (p.105)

How to Operate the Menu

This section explains operation methods for [📷 Rec. Mode] menu, [▶ Playback] menu, [⏏ Set-up] menu and [C Custom Setting] menu.

Displaying the Menu screen

1 Press the MENU button in Capture mode.

The [📷 Rec. Mode] menu appears on the LCD monitor.

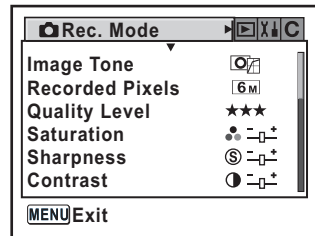
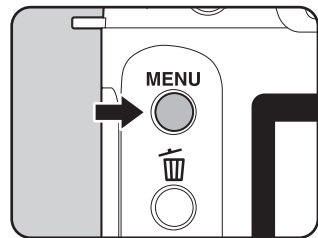

2 Press the four-way controller (⬇).

[▶ Playback] menu, [⏏ Set-up] menu and [C Custom Setting] menu appear in order each time the four-way controller is pressed.

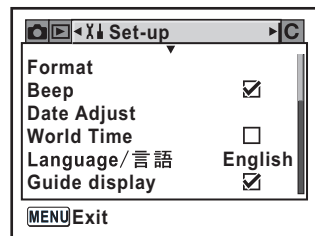

Select a menu item and set

Procedure to set the [Quality Level] on the [📷 Rec. Mode] menu is explained as an example.

3 Use the four-way controller (⬆️⬇️) to choose an item.

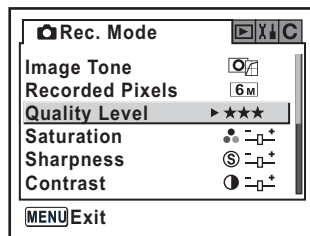

4 Press the four-way controller (⬅️).

Available [Quality Level] options appear.

Press the four-way controller (⬅️) to move to the pop-up menu if there is one.

When the quality level is changed, the number of recordable images at that quality level appears on the screen.

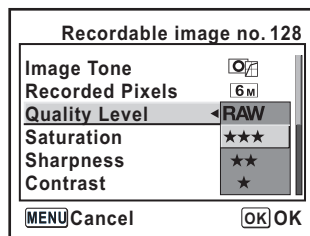

5 Use the four-way controller (⬆️⬇️) to select a setting.

6 Press the OK button.

The camera returns to the menu screen. Next, set other items.

Press the **MENU** button to return to Capture or Playback mode.



Even after you press the **MENU** button and close the menu screen, your settings will not be saved if the camera is turned off improperly (such as by removing the batteries while the camera is on).



- You can use the e-dial to switch among the [📷 Rec. Mode] menu, the [▶ Playback] menu, [X↓ Set-up] menu, and [C Custom Setting] menu when no pop-up menu is displayed.
- If the **MENU** button is pressed in Capture mode, the [📷 Rec. Mode] menu appears. If the **MENU** button is pressed in Playback mode, the [▶ Playback] menu appears.

[📷 Rec. Mode] Menu Setting Items

Perform settings related to capturing in the [📷 Rec. Mode] menu.

| Item | Function | Page |
|------------------|--|-------|
| Image Tone | Sets the color tone of pictures. | p.110 |
| Recorded Pixels | Sets the recording size of images. | p.111 |
| Quality Level | Sets the image quality. | p.112 |
| Saturation | Sets the color saturation. | p.113 |
| Sharpness | Makes the image outlines sharp or soft. | p.113 |
| Contrast | Sets the image contrast. | p.113 |
| Auto Bracket | Sets Auto Bracket shooting. | p.147 |
| AE Metering | Selects the part of the screen to use for measuring brightness and determining exposure. | p.132 |
| Swthc dst msr pt | Selects the part of the screen to set focus to. | p.124 |
| AF Mode | Selects the autofocus mode. | p.123 |
| Flash Exp. Comp. | Adjusts the flash exposure to brighten or darken the image. | p.150 |

[▶ Playback] Menu Setting Items

Perform settings related to playback and editing images in the [▶ Playback] menu.

| Item | Function | Page |
|------------------|--|-------|
| Plybk dsply mthd | Sets shooting information to show during playback and whether to display overexposed area warning. | p.163 |
| Instant Review | Sets the Instant Review time. | p.173 |
| Preview Display | Sets to display overexposed area warning or histogram during Instant Review or Digital Preview. | p.174 |
| Digital Filter | Changes the color tone of captured images, adds softening and slimming effects, or adjusts the brightness. | p.73 |
| Slideshow | Plays back recorded images one after another. | p.70 |

[X] Set-up] Menu Setting Items

Perform various settings related to the camera in the [X] Set-up] menu.

| Item | Function | Page |
|------------------|---|-------|
| Format | Formats the SD Memory Card. | p.165 |
| Beep | Switches the beep tone on/off. | p.166 |
| Date Adjust | Sets the date format and time. | p.166 |
| World Time | Sets display of local time when traveling abroad. | p.167 |
| Language/言語 | Changes the language in which menus and messages appear. | p.170 |
| Guide display | Sets to display indicators in LCD monitor. | p.170 |
| Brightness Level | Changes the brightness of the LCD monitor. | p.171 |
| Video Out | Sets the output format to the TV monitor. | p.171 |
| Transfer Mode* | Sets the USB cable connection (PC or printer). | p.86 |
| Auto Power Off | Sets the time to turn off automatically. | p.172 |
| Folder Name | Sets the method used to assign folder names for storing images. | p.172 |
| File # | Sets the method used to add file numbers. | p.173 |
| Sensor Cleaning | Locks the mirror in the up position for cleaning the CCD. | p.185 |
| Reset | Resets all settings other than Date Adjust, Language, Video Out and World Time. | p.175 |

* Refer to p.11 of the "PENTAX PHOTO Browser 3/PENTAX PHOTO Laboratory 3 Operating Manual" for details on connecting the camera to a PC.

[C Custom Setting] Menu Setting Items

Set custom functions to fully use the functions of a SLR camera with the Custom Function Menu. The default setting does not use Custom Function.

[C Custom Setting] menu settings are activated when [Setting], the first item, is (on).

| Item | Function | Page |
|----------------------|---|--------------|
| Setting | Sets to use the Custom Function Menu. | — |
| Noise Reduction | Sets to use Noise Reduction in slow speed shooting. | — |
| Expsr Setting Steps | Sets the adjustment steps for exposure. | p.144 |
| ISO Corction in AUTO | Sets the automatic ISO correction range for [AUTO] setting in [Sensitivity]. | p.117 |
| ISO Snsvtvy Wrn Dspl | Sets the maximum sensitivity level. ISO Sensitivity Warning Display appears when exceeded. | p.118 |
| Link AF Point and AE | Sets whether to link the exposure value and the AF point in the focusing area (focus position) during multi-segment metering. | p.133 |
| Meter Operating Time | Sets the exposure metering time. | p.133 |
| AE-L with AF locked | Sets to fix exposure value when focus is locked. | p.127 |
| Recordable Image No. | Sets to switch number of recordable images in the LCD panel and viewfinder to number of continuous shooting recordable images when shutter release button is pressed halfway. | — |
| OK btn when shooting | Sets the action for the OK button when pressed during shooting. | p.122, p.125 |
| AE-L btnn on M expsr | Selects the exposure adjustment method when the AE-L button is pressed in M (Manual) mode. | p.142 |
| Superimpose AF Area | Sets whether to display the selected AF point (focus position) in the viewfinder. | p.124 |

| Item | Function | Page |
|----------------------|---|-------|
| AF in remote control | Sets to use Autofocus when shooting with remote control. Shutter releases after AF activates if shutter is released from remote control when [On]. Shutter cannot be released until in focus. AF does not activate at shutter release from remote control when [Off]. | — |
| FI with S lens used | Sets to enable focus indicator when screw mount lens is in use. Lens is recognized even when lens is not attached to the camera when enabled. | — |
| Using aperture ring | Sets to enable shutter release when lens aperture ring is set at other than A . | p.184 |
| Release when Chrging | Sets to release shutter while the built-in flash is charging. | p.151 |
| Preview Method | Selects Digital Preview or Optical Preview when the main switch is in the preview position (📷). Digital Preview lets you check the composition, exposure and focus on the LCD monitor before taking the picture. Optical Preview lets you check the depth of field with the viewfinder. | p.149 |
| Mag to Strt Zm Plybk | Sets the initial magnification of the zoom playback. Choose from [1.2 times], [2 times], [4 times], [8 times] and [12 times]. The default setting is [1.2 times]. | — |
| Man. WB Measurement | Sets to meter entire screen or Spot area when setting white balance to manual. | p.115 |
| Color Space | Sets the color space to use. | p.119 |
| Reset Custom Fncion | Resets all the settings in the Custom Function menu to the defaults. | p.176 |

Capture Mode

Press the **Fn** button in Capture mode. The Fn menu appears.

Press the four-way controller () to set the operation.

Four-way
controller

Playback Mode

Press the **Fn** button in Playback mode. The Fn menu appears.

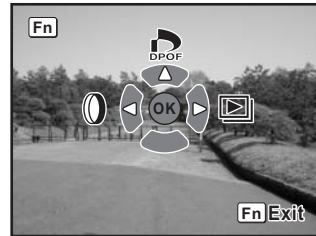









Press the four-way controller (▲◀▶▶) to set the operation.

| Four-way controller | Item | Function | Page |
|---------------------|----------------|--|------|
| ▲ | DPOF Settings | Sets the DPOF settings. | p.82 |
| ◀▶ | Digital Filter | Changes the color tone of captured images, adds softening and slimming effects, or adjusts the brightness. | p.73 |
| ▶▶ | Slideshow | Plays back recorded images one after another. | p.70 |

You can switch the mode dial to the dial indicator.

Mode dial

| Item | | Page |
|--|---|------|
|  (Auto) | Subject with standard background. There is no background blur. | |
|  (Portrait) | Portrait mode. Optimizes for portraits. | |
|  (Landscape) | Landscape mode. Emphasizes foreground, background, and the sky, resulting in a sharp image. | |
|  (Flowers) | Flowers mode. Captures vibrant pictures of flowers or other subjects at short distances. | p.47 |
|  (Sports) | Sports mode. Takes sharp pictures of a quickly moving subject, such as a sporting event. | |
|  (Night Scene Portrait) | Night Scene Portrait mode. Lets you capture people against a night view or dusk. | |
|  | The built-in flash is deactivated. Other settings are the same as the Normal mode in AUTO PICT . | |
|  | Selects from 8 situations depending on the shooting conditions. | |

 (Night Scene Portrait), the shutter speed becomes slower in dark places, even if the built-in flash is used. To prevent camera shake, mount the camera on a tripod.

| Item | Function | Page |
|-------------------------------|---|-------|
| P (Program) | Automatically sets shutter speed and aperture to the proper exposure when taking pictures. | p.135 |
| Tv (Shutter Priority) | Lets you set the desired shutter speed for expressing the motion of moving subjects. Take pictures of fast moving subjects that look still or subjects that give a sense of movement. | p.136 |
| Av (Aperture Priority) | Lets you set the desired aperture for controlling the depth of field. Use it to obtain a blurred or sharp background. | p.138 |
| M (Manual) | Lets you set shutter speed and aperture to capture the picture with creative intent. | p.140 |
| B (Bulb) | Lets you capture images that require slow shutter speeds such as fireworks and night scenes. | p.142 |

Memo

5 Function Reference



Introduces functions to further enhance your *K110D* experience.

| | |
|---|------------|
| Setting the Recorded Pixels and Quality Level | 110 |
| Focusing | 120 |
| Setting the Exposure | 130 |
| Checking the Composition, Exposure and Focus Before Shooting | 148 |
| Using the Built-in Flash | 150 |
| Settings During Playback | 163 |
| Camera Settings | 165 |
| Resetting to Default Settings | 175 |

Setting the Recorded Pixels and Quality Level

Setting the Image Tone

Set the basic color tone of pictures. The default setting is  (Bright).

| | | |
|---|---------|---|
|  | Bright | Images are finished brightly, with high contrast and sharpness. |
|  | Natural | Images are finished naturally and suitable for retouching. |

Set in [Image Tone] in the [ Rec. Mode] menu. (p.100)

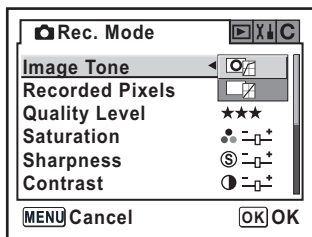

5

Function Reference



Setting cannot be changed in Picture mode and **SCN** mode (p.47). Setting is fixed to  (bright).

Setting the Recorded Pixels

You can select the number of recorded pixels from **6M**, **4M** and **1.5M**. The more pixels there are, the larger the picture and the bigger the file size. The file size will also differ according to quality level settings. The default setting is **6M** 3008×2000 (JPEG).

| | | |
|-------------|-------------------------------------|---|
| 6M | 3008×2008 (RAW) 3008×2000 (JPEG) | Suited for printing on A3 paper (297×420 mm). |
| 4M | 2400×1600 | Suited for printing on A4 paper (210×297 mm). |
| 1.5M | 1536×1024 | Suited for printing on A5 paper (148×210 mm). |

Set in [Recorded Pixels] in the [ Rec. Mode] menu. (p.100)

When the number of recorded pixels is changed, the number of recordable images appears on the screen.

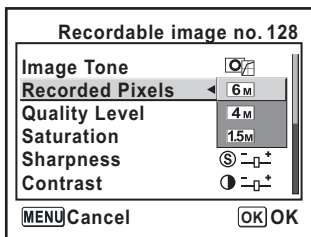

[Recorded Pixels] cannot be selected if the [Quality Level] is set to **RAW**. (Fixed at 3008×2008)

Setting the Quality Level

You can set the image quality level. The file size will also differ according to the Recorded Pixels settings. The default setting is ★★★ (Best).

| | | |
|-----|--------|--|
| RAW | RAW | RAW data is CCD output data saved without processing. Effects such as White Balance, Contrast, Saturation and Sharpness are not applied to the image but such information is saved. Transfer to a PC, apply effects with the enclosed PENTAX PHOTO Laboratory 3 and create JPEG and TIFF images. |
| ★★★ | Best | Lowest compression rate, suited for printing large pictures such as A4 size. Image is saved in JPEG format. |
| ★★ | Better | Standard compression rate, suited for viewing as photographs or on your computer screen. Image is saved in JPEG format. |
| ★ | Good | Highest compression rate, suitable for attaching to e-mail or posting on websites. Image is saved in JPEG format. |

Set in [Quality Level] in the [📷 Rec. Mode] menu. (p.100)

When the quality level is changed, the number of recordable images at that quality level appears on the screen.

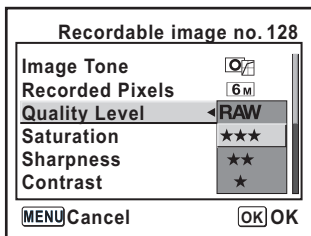

Setting the Saturation/Sharpness/Contrast

Select from five levels of Saturation, Sharpness and Contrast. The default setting is [0 (Standard)] for all.

| | |
|------------|---|
| Saturation | Sets the color saturation. |
| Sharpness | Makes the image outlines sharp or soft. |
| Contrast | Sets the image contrast. |

Set [Saturation], [Sharpness] and [Contrast] in the [📷 Rec. Mode] menu. (p.100)



Settings cannot be changed in Picture mode and **SCN** mode (p.47).

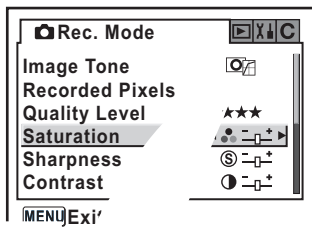

Towards + : Higher saturation

Towards - : Lower saturation

Towards + : Higher sharpness







Towards - : Lower sharpness

Towards + : Higher contrast







Towards - : Lower contrast

Setting the White Balance

White balance is a function for adjusting the color of an image so that white objects appear white. Set the white balance if you are not satisfied with the color balance of pictures taken with white balance set to **AWB** (Auto), or to intentionally apply a creative effect to your images. The default setting is **AWB** (Auto).

| | | |
|---|-------------------|---|
| AWB | Auto | Automatically adjusts the white balance. (About 4000 to 8000K) |
|  | Daylight | For use when taking pictures in sunlight. (About 5200K) |
|  | Shade | For use when taking pictures in the shade. It reduces the bluish color tones in a picture. (About 8000K) |
|  | Cloudy | For use when taking pictures on cloudy days. (About 6000K) |
|  | Fluorescent Light | For use when taking pictures under fluorescent lighting. Select the type of fluorescent light, from W (white) (About 4200K), N (neutral white) (About 5000K), and D (daylight) (About 6500K). |
|  | Tungsten Light | For use when taking pictures under light bulb or other tungsten light. It reduces the reddish color tones in a picture. (About 2850K) |
|  | Flash | For use when taking pictures using the built-in flash. (About 5400K) |
|  | Manual | Use this to manually adjust the white balance according to the lighting so that white objects appear as a natural white. |

* The color temperature (K) is an estimate. This does not indicate precise colors.

* The white balance is adjusted based on preset values provided in the camera when set to  (Daylight),  (Shade),  (Cloudy),  (Fluorescent Light),  (Tungsten Light), or  (Flash).

Set [White Balance] in the Fn menu. (p.104)

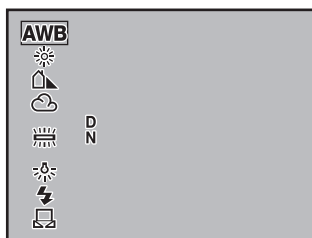

- Refer to p.115 for manual adjustment method.
- White balance cannot be adjusted in Picture mode and **SCN** mode (p.47).

Color Temperature

The color of light shifts towards blue as the color temperature rises, and towards red as the color temperature falls. Color temperature describes this change in light color in terms of absolute temperature (K: Kelvin). This camera is capable of setting the white balance to enable taking pictures with natural coloring under a variety of lighting conditions.



Adjusting the White Balance Manually

You can adjust the white balance depending on the light source when taking pictures. With Manual White Balance, the camera can store delicate shades that cannot be precisely adjusted with the white balance preset values provided in the camera (p.114). This provides the optimum white balance for your surroundings.

- 1** Set the mode dial to **P**, **Tv**, **Av**, or **M**.
 - 2** Press the **Fn** button.
The Fn menu appears.
 - 3** Press the four-way controller (⤵).
- The White Balance screen appears.

- 4** Use the four-way controller (⏮) to select  (**Manual**).

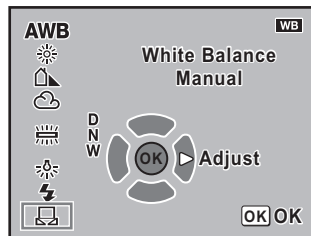

- 5** Press the four-way controller (⏮).

The message screen appears.

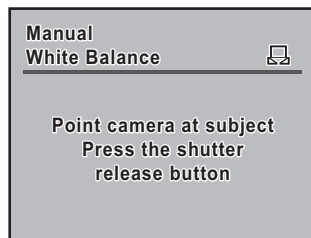

- 6** Fully display a white or gray sheet of paper in the viewfinder under the light to adjust white balance.

- 7** Press the shutter release button fully.

Slide the focus mode lever to **MF** when the shutter cannot be released. [OK] appears on the LCD monitor when setting is completed. [NG] appears when setting is not completed successfully.

- 8** Press the OK button.



- No image is recorded when the shutter release button is pressed to adjust the white balance.
- Press the **Fn** button when adjustment is unsuccessful to set again.
- You can use [Man. WB Measurement] in the [C Custom Setting] menu (p.103) to set the area to measure for white balance when setting manually. Even if [Entire screen] is selected, white balance of the entire screen is measured normally but the exposure metering is measured according to the [AE Metering] setting in the [Rec. Mode] menu (p.132). White Balance is only adjusted in the spot metering area (p.133) if [Spot metering area] is selected.
- If picture is extremely overexposed or underexposed, white balance may not be adjusted. In this case, adjust appropriate exposure and adjust the white balance.

Setting the Sensitivity

You can set the sensitivity to suit the brightness of the surroundings. The sensitivity can be set to [AUTO] or within a sensitivity range equivalent to ISO 200 to 3200. The default setting is [AUTO].

Set [Sensitivity] in the Fn menu. (p.104)

When set to [AUTO], the range set with [ISO Corction in AUTO] in the [**C** Custom Setting] menu is displayed enclosed in brackets.

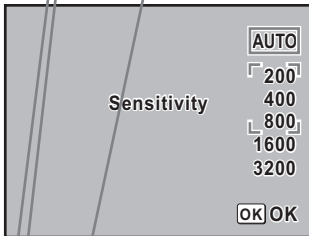

Captured images can show more noise if higher Sensitivity is set.

5

Setting the Range of Automatic Correction in AUTO

Set range to automatically correct sensitivity when Sensitivity is set to [AUTO]. The sensitivity is automatically corrected in the range of [ISO 200-800] by default.

| | | |
|---|--------------|---|
| 1 | ISO 200-800 | Corrects sensitivity automatically in the range of ISO 200 to 800. |
| 2 | ISO 200-400 | Corrects sensitivity automatically in the range of ISO 200 to 400. |
| 3 | ISO 200-1600 | Corrects sensitivity automatically in the range of ISO 200 to 1600. |
| 4 | ISO 200-3200 | Corrects sensitivity automatically in the range of ISO 200 to 3200. |

Set in [ISO Corction in AUTO] in the [**C** Custom Setting] menu. (p.102)



Sensitivity is not corrected in the following cases.

- Exposure mode is **M** (Manual) or **B** (Bulb) mode
- Flash is discharged
- Auto bracketing is set
- EV Compensation is adjusted

ISO Sensitivity Warning Display

ISO Sensitivity Warning appears in the viewfinder when a sensitivity value of your choice is reached or exceeded. Set a sensitivity that is not regularly used to avoid forgetting to reset when sensitivity is raised. ISO Sensitivity Warning is not displayed by default.

| | | |
|---|----------|--|
| 1 | Off | ISO Sensitivity Warning is not displayed. |
| 2 | ISO 400 | ISO Sensitivity Warning is displayed when ISO 400 is set or exceeded. |
| 3 | ISO 800 | ISO Sensitivity Warning is displayed when ISO 800 is set or exceeded. |
| 4 | ISO 1600 | ISO Sensitivity Warning is displayed when ISO 1600 is set or exceeded. |
| 5 | ISO 3200 | ISO Sensitivity Warning is displayed when ISO 3200 is set. |

Set in [ISO Snsvtv Wrn Dspl] in the [**C** Custom Setting] menu. (p.102)

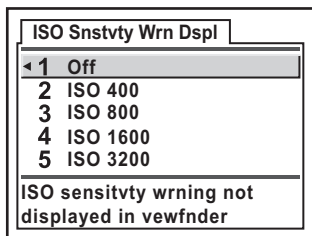

ISO (ISO Sensitivity Warning) appears in the viewfinder when the set sensitivity is set or exceeded.

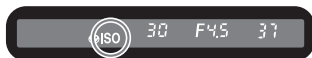

ISO Sensitivity Warning is not displayed even if the automatically corrected sensitivity exceeds the set sensitivity setting. (p.117)

Setting the Color Space

You can set the color space to use. The default setting is [sRGB].

| | | |
|---|----------|-------------------------------|
| 1 | sRGB | Sets to sRGB color space. |
| 2 | AdobeRGB | Sets to AdobeRGB color space. |

Set in [Color Space] in the [**C** Custom Setting] menu. (p.103)

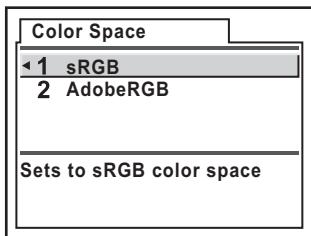

File names differ depending on the color space setting as shown below.

For sRGB : IMGpxxxx.JPG

For AdobeRGB : _IGPxxxx.JPG

[xxxx] is the file number and numbering continues from the last stored file number.

Color Space

Color ranges for various input/output devices, such as digital cameras, monitors, and printers, differ.

This color range is called the Color Space.

To recreate different color spaces in different devices, standard color spaces have been proposed. This camera supports sRGB and AdobeRGB.

sRGB is mainly used for devices such as a PC.

AdobeRGB covers a wider area than sRGB and is used for occupational uses such as industrial printing.

An image created in AdobeRGB may appear lighter than an image created in sRGB when output from a sRGB compatible device.

You can focus with the following methods.

| | | |
|-----------|--------------|---|
| AF | Autofocus | The camera is focused when the shutter release button is pressed halfway. |
| MF | Manual focus | Manually adjust the focus. |

Using the Autofocus

You can also choose the autofocus mode from **A.F.S** (Single mode) where the shutter release button is pressed halfway to focus on the subject and the focus is locked at that position, and **A.F.C** (Continuous mode) where the subject is kept in focus by continuous adjustment while the shutter release button is pressed halfway. (p.123)

5

Function Reference

- 1 Set the focus mode lever to **AF**.

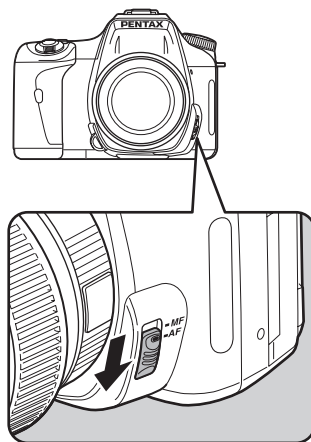

2 Look through the viewfinder and press the shutter release button halfway.

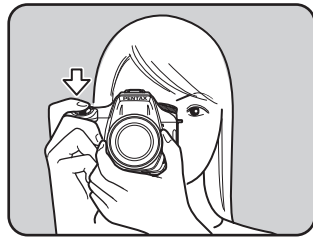

The focus indicator ● appears in the viewfinder when focused (if it is blinking, the subject is not in focus).

☞ Subjects that are Difficult to Focus on (p.46)

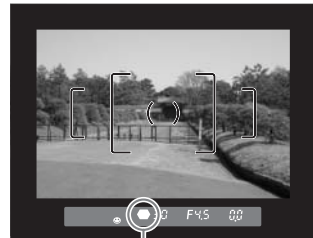

Focus indicator



- In **A.F.S** (Single mode), the focus is locked (focus lock) while ● is lit. To focus on another subject, take your finger off the shutter release button first.
- During 🏃 (Moving Object) mode, when the **SCN** mode is set to 👶 (Kids) or 🐾 (Pet) or when the [AF Mode] in the [📷 Rec. Mode] is set to **A.F.C** (Continuous mode) (p.123), focus is adjusted continuously, tracking the moving object as long as the shutter release button is kept pressed halfway.
- The shutter cannot be released until the subject is in focus in **A.F.S** (Single mode) (p.123). If the subject is too close to the camera, move back and take the picture. Adjust the focus manually if the subject is difficult to focus (p.46). (p.128)
- In **A.F.S** (Single mode), press the shutter release button halfway. The built-in flash will discharge automatically several times, enabling the autofocus to focus on the subject easier if the subject is in a dark area and the built-in flash is available.
- Regardless if the camera is set to **A.F.S** (Single mode) or **A.F.C** (Continuous mode), the camera automatically tracks the subject if it is determined to be a moving object.

Using the OK Button to Focus on the Subject

You can set the camera so that the focusing is not performed when the shutter release button is pressed halfway and is performed when the **OK** button is pressed. This is useful when you wish to temporarily use autofocus while using manual focus.

Set [Enable AF] in [OK btn when shooting] in the [C Custom Setting] menu. (p.102)

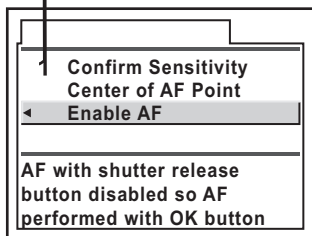

5

Only use this function with lenses that are compatible with Quick Shift Focus (lenses with “DA” or “D FA”).

- When [Confirm Sensitivity] is selected, press the **OK** button to display the currently selected sensitivity in the viewfinder. When [Sensitivity] is set to [AUTO] in the Fn menu, the automatically selected value is displayed.
- When [Center of AF Point] is selected, the AF point can be set to the center by pressing the **OK** button (Only when [Swch dst msr pt] is set to  (Select)).
- Select [Cancel AF]. **MF** appears in the viewfinder while the **OK** button is pressed. Autofocus does not activate when the shutter release button is pressed. This is useful when you wish to temporarily use manual focus while using autofocus.

You can focus using the focus ring and release the shutter while the **OK** button is pressed when using a lens compatible with Quick Shift Focus (take your finger off the **OK** button to immediately return to AF mode).



Setting the AF Mode

You can choose from the following two autofocus modes. The default setting is **A.F.S** (Single mode).

| | | |
|--------------|-----------------|---|
| A.F.S | Single mode | When the shutter release button is pressed halfway to focus on the subject, the focus is locked at that position. |
| A.F.C | Continuous mode | The subject is kept in focus by continuous adjustment while the shutter release button is pressed halfway. |

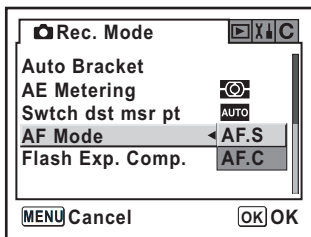
Set [AF Mode] in the [ Rec. Mode] menu (p.100).







- Setting cannot be changed in Picture mode and **SCN** mode (p.47).
- **A.F.C** (Continuous mode) can be set when the mode dial is set to **P**, **Tv**, **Av**, **M** or **B**. The autofocus mode is set to **A.F.C** in  (Moving Object) of Picture mode or  (Kids) or  (Pet) of **SCN** mode.

Selecting the Focusing Area (AF Point)

Choose the part of the viewfinder to set focus to. The default setting is **AUTO** (Auto).

The selected AF point lights red in the viewfinder. (Superimpose AF Area)

| | | |
|---|--------|--|
|  | Auto | The camera selects the optimum AF point even if the subject is not centered. |
|  | Select | Sets the focusing area to one of the eleven points in the AF area. |
|  | Center | Sets the focusing area to the center of the viewfinder. |

Set in [Swch dst msr pt] in the [ Rec. Mode] menu (p.100).

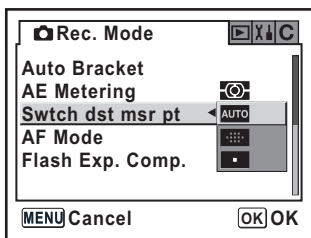

5



AF point is not displayed in the viewfinder when [Off] is selected for [Superimpose AF Area] in the [**C** Custom Setting] menu. (p.102)

Setting the Focus Position in the Viewfinder

1 Select  (Select) in [Swch dst msr pt] in the [📷 Rec. Mode] menu.

2 Look through the viewfinder and check the position of the subject.

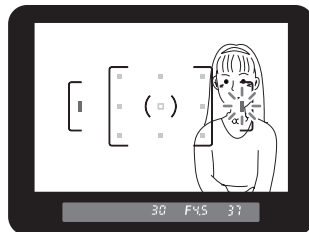

3 Use the four-way controller (   ) to select the desired AF point.

The AF point lights red in the viewfinder (Superimpose AF Area) and you can check where you set the AF point.



- When [OK btn when shooting] in the [C Custom Setting] menu is set to [Center of AF Point], press the **OK** button to set the AF point to the center if the AF point other than the center is selected for  (Select).
- When [OK btn when shooting] is set to [Confirm Sensitivity] in the [C Custom Setting] menu, press the **OK** button to display the currently selected sensitivity in the viewfinder. When [Sensitivity] is set to [AUTO] in the Fn menu, the automatically selected value is displayed.
- The AF point is fixed to the center position regardless of this setting with lenses other than DA, D FA, FA J, FA or F lenses.

Fixing the Focus (Focus Lock)

If the subject is outside the range of the focusing area, the camera cannot automatically focus on the subject. In this situation, you can aim the focusing area toward the subject, use focus lock and recompose the picture.

1 Frame the desired composition for your picture in the viewfinder.

Use focus lock function when the subject you wish to focus on is not inside the focusing area.

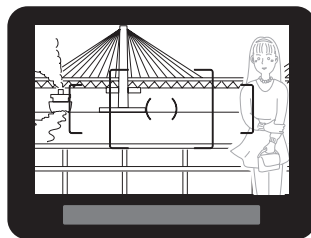

(Example)

The person is out of focus and the background is focused instead.

2 Center the subject to focus in the viewfinder and press the shutter release button halfway.

The focus indicator  appears and you will hear a beep when the subject comes into focus (if it is blinking, the subject is not in focus).

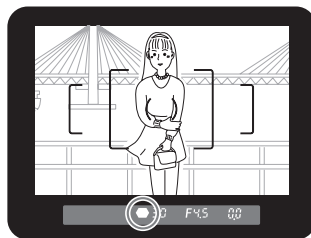





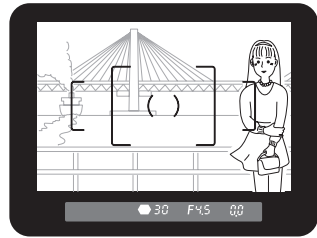

3 Lock the focus.

Keep the shutter release button pressed halfway. The focus will remain locked.

4 Re-compose the picture while keeping the shutter release button pressed halfway.



- The focus is locked while the focus indicator  is lit.
- Turning the zooming ring in focus lock mode may cause the subject to be out of focus.
- The beep can be turned off. (p.166)
- You cannot set focus lock when the [AF Mode] in the [📷 Rec. Mode] is set to **AFC** (Continuous mode), the Capture mode is set to  (Moving Object) or **SCN** mode is set to  (Kids) or  (Pet). In **AFC** (Continuous mode),  (Moving Object) mode or  (Kids) or  (Pet) of **SCN** mode, the autofocus continues to focus on the subject until the shutter is released. (Continuous Autofocus)

Fixing Exposure when Focus is Locked

Set [AE-L with AF locked] in the [C Custom Setting] menu (p.102) to fix the exposure value while focus is locked. Exposure is not fixed by default during focus lock.

| | | |
|---|-----|---|
| 1 | Off | Exposure is not fixed when focus is locked. |
| 2 | On | Exposure is fixed when focus is locked. |

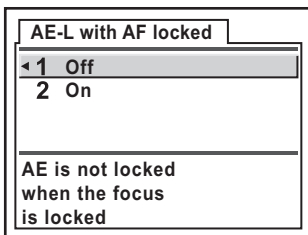

Adjusting the Focus Manually (Manual Focus)

When you adjust the focus manually, you can either check with the focus indicator in the viewfinder or use the viewfinder matte field to adjust focus.

Using the Focus Indicator

You can manually adjust the focus using the focus indicator .

- 1 **Set the focus mode lever to MF.**

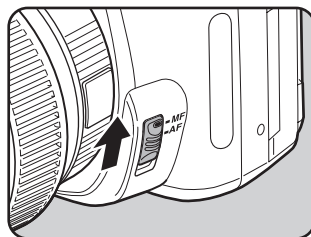

- 2 **Look through the viewfinder, press the shutter release button halfway and turn the focusing ring.**

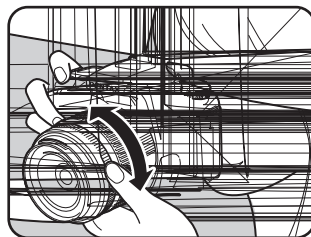

The focus indicator  appears and you will hear a beep when the subject comes into focus.

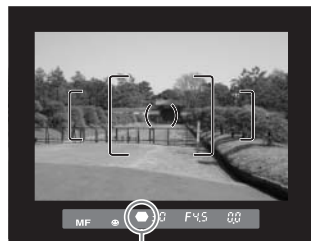

Focus indicator



- Use the matte field in the viewfinder when the subject is difficult to focus (p.46) and the focus indicator will not stay lit.
- The beep can be turned off. (p.166)

Using the Viewfinder Matte Field

You can manually adjust the focus using the viewfinder matte field.

- 1 Set the focus mode lever to MF.**

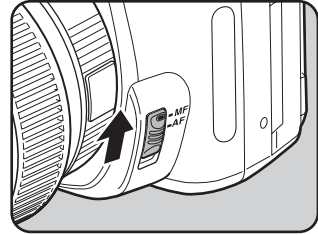

- 2 Look through the viewfinder and turn the focusing ring until the subject looks sharp on the screen.**

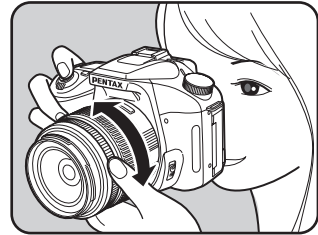

Effect of Aperture and Shutter Speed

Correct exposure of the subject is determined by the combination of shutter speed and aperture setting. There are many correct combinations of shutter speed and aperture for a particular subject. Different combinations produce different effects.

Effect of Shutter Speed

The shutter speed determines the length of time that light is allowed to strike the CCD. Adjust the amount of light striking the CCD.

- **Using slower shutter speed**

If the subject is moving, the image will be blurred because the shutter is open longer.

It is possible to enhance the effect of motion (rivers, waterfalls, waves, etc.) by intentionally using a slower shutter speed.



- **Using faster shutter speed**

Choosing a faster shutter speed will allow freezing the action of a moving subject.

A faster shutter speed also helps preventing camera shake.

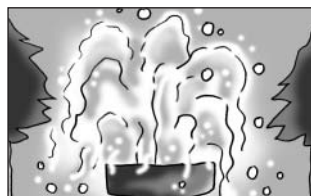

Effect of Aperture

Adjust the amount of light hitting the CCD by changing the aperture.

● Opening the aperture (reduce the aperture value)

Objects closer and farther than the focused subject will be more out of focus. For instance, if you take a picture of a flower against a landscape with the aperture open, the landscape in front and behind the flower will be blurred, emphasizing only the flower.

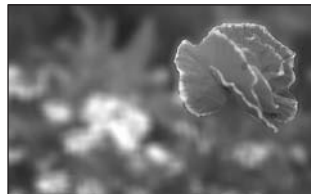

● Closing the aperture (increase the aperture value)

The range in focus expands forward and backward. For instance, if you take a picture of a flower against a landscape with the aperture narrowed, the landscape in front and behind the flower will be in focus.







Depth of Field



When you focus on a portion of the subject, there is a range in which object closer and farther will also be in focus. This focused range is called the depth of field.

- The depth of field for the *K110D* differs depending on the lens but compared to a 35 mm camera, the value is roughly one aperture setting lower (the focused range becomes narrower).
- The wider the wide-angle lens, and the farther away the subject, the deeper the depth of field is (some zoom lenses do not have a scale for depth of field because of their structure).

| | | | |
|-------------------------|-------------------------|--------|-------------------------|
| Depth of field | Shallow | ←————→ | Deep |
| Area of focus | Narrow | ←————→ | Wide |
| Aperture | Open (Smaller value) | ←————→ | Close (Larger value) |
| Lens focal length | Longer (Telephoto) | ←————→ | Shorter (Wide-angle) |
| Distance to the subject | Near | ←————→ | Far |

Selecting the Metering Method

Choose the part of the screen to use for measuring brightness and determining exposure.  (Multi-segment metering),  (Center-weighted metering) or  (Spot metering) mode can be selected. The default setting is  (Multi-segment metering).

| | | |
|---|--------------------------|---|
|  | Multi-segment metering | Segments the screen in 16 parts, meters each portion and determines the appropriate exposure. |
|  | Center-weighted metering | Measures the entire screen with an emphasis on the center and determines the exposure. |
|  | Spot metering | Measures only the center of the screen and determines exposure. |

5 Set in [AE Metering] in the [ Rec. Mode] menu. (p.100)

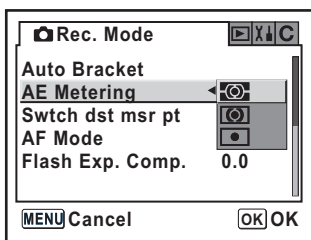

Using the Multi-Segment Metering

The scene in the viewfinder is metered in 16 different zones as shown in the illustration when using the multi-segment metering. This mode automatically determines what level of brightness is in which portion.

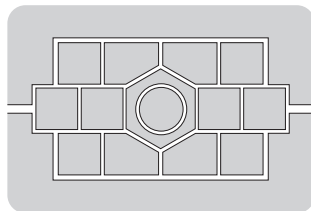

The center-weighted metering mode is automatically set even if you select the multi-segment metering mode when using a lens other than a DA, D FA, FA J, FA, F or A lens (can only be used if permission is set in [Using aperture ring] in the [ Custom Setting] menu (p.103)).

Linking AF Point and AE During Multi-Segmented Metering

In [Link AF Point and AE] (p.102) of the [C Custom Setting] menu, you can link the exposure and AF point in the focusing area during multi-segment metering. The default setting is [Off].

| | | |
|---|-----|--|
| 1 | Off | Exposure is set separately from AF point. |
| 2 | On | Exposure is set in accordance with AF point. |

Using the Center-Weighted Metering

Metering is weighted at the center of the screen. Use this metering when you want to compensate the exposure by experience, instead of leaving it to the camera. The illustration shows that sensitivity increases as the pattern height increases (center). This mode does not automatically compensate for backlit scenes.

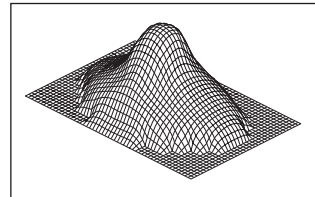

Using the Spot Metering

With spot metering, brightness is measured only within a limited area at the center of the screen as shown in the illustration. You can use this in combination with the AE lock (p.144) when the subject is extremely small and proper exposure is difficult to obtain.

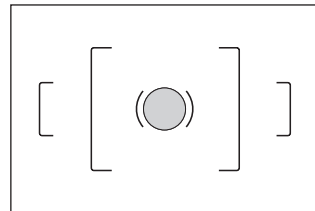

Setting the Meter Operating Time

Sets the exposure metering time in [Meter Operating Time] in the [C Custom Setting] menu (p.102). The default setting is [10 sec].

| | | |
|---|--------|---|
| 1 | 10 sec | Sets exposure metering timer to 10 seconds. |
| 2 | 3 sec | Sets exposure metering timer to 3 seconds. |
| 3 | 30 sec | Sets exposure metering timer to 30 seconds. |

Changing the Exposure Mode

Apart from the Picture and **SCN** modes, this camera features the following five exposure modes.

Use the mode dial (p.106) to change the exposure mode.

| Exposure Mode | Description | Exposure Compensation | Change Shutter Speed | Change Aperture |
|----------------------------------|--|-----------------------|----------------------|-----------------|
| P (Program) | Automatically sets shutter speed and aperture for taking pictures at the proper exposure. | Yes | No | No |
| Tv (Shutter Priority) | Lets you set the desired shutter speed for expressing moving subjects. Take pictures of fast moving subjects that look still or subjects that show movement. | Yes | Yes | No |
| Av (Aperture Priority) | Lets you set the desired aperture for controlling the depth of field. Use to blur or sharpen the background. | Yes | No | Yes |
| M (Manual) | Lets you set shutter speed and aperture to capture the picture with creative intent. | No | Yes | Yes |
| B (Bulb) | Lets you capture images that require slow shutter speeds such as fireworks and night scenes. | No | No | Yes |

Automatically set for taking pictures

e.

e

n is displayed in

Using the Tv (Shutter Priority) Mode

Set the shutter speed faster and capture fast moving subjects as if they are still or slow down the shutter speed and capture images emphasizing subject movement.

Aperture value is automatically set to appropriate exposure depending on the shutter speed.

☞ Effect of Aperture and Shutter Speed (p.130)

1 Set the mode dial to Tv.

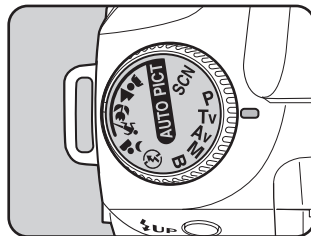

2 Turn the e-dial and adjust the shutter speed.

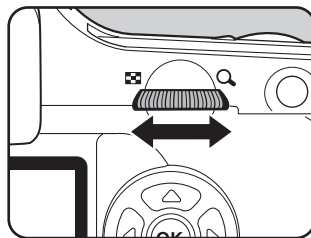

The shutter speed and aperture value are displayed in the viewfinder and on the LCD panel.





- Turn the e-dial while pressing the **Av** button and change the EV Compensation value. (p.143)
- Set the shutter speed in increments of 1/2 EV or 1/3 EV. Set in [Expsr Setting Steps] in the [**C** Custom Setting] menu. (p.144)
- You can automatically correct the sensitivity if appropriate exposure cannot be set with the set criteria. Set [Sensitivity] to [AUTO] in the Fn menu. (p.117)
- Set the aperture to the **A** position while holding down the auto-lock button when using a lens with an aperture ring.

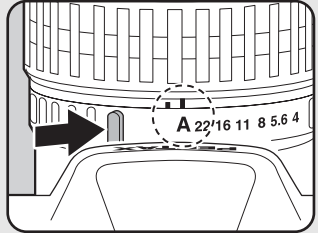

Exposure Warning

If the subject is too bright or too dark, the aperture value will blink in the viewfinder and on the LCD panel. If the subject is too bright, choose a faster shutter speed. If it is too dark, choose a slower shutter speed. When the aperture value indication stops blinking, you can take the picture with proper exposure.



If both the shutter speed and aperture value are blinking, this indicates being out of metering range and the proper exposure cannot be obtained even if the shutter speed is adjusted.

Use an ND (Neutral Density) filter if the subject is too bright.

Use a flash if it is too dark.

Using the Av (Aperture Priority) Mode

Set aperture for controlling the depth of field. The depth of field is deeper and the front and back of the focused object is clear when aperture is set to a large value. The depth of field is shallower and the front and back of the focused object is blurred when aperture is set to a small value.

Shutter speed is automatically set to appropriate exposure depending on the aperture value.

☞ Effect of Aperture and Shutter Speed (p.130)

1 Set the mode dial to Av.

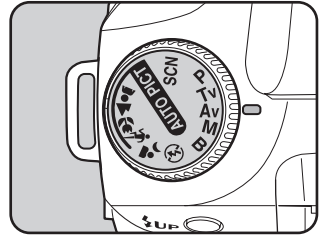

2 Turn the e-dial and adjust the aperture value.

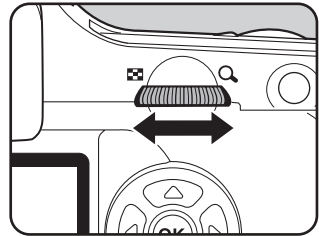

The shutter speed and aperture value are displayed in the viewfinder and on the LCD panel.





- Turn the e-dial while pressing the **Av** button and change the EV Compensation value. (p.143)
- Set the aperture value in increments of 1/2 EV or 1/3 EV. Set in [Expsr Setting Steps] in the [**C** Custom Setting] menu. (p.144)
- You can automatically correct the sensitivity if appropriate exposure cannot be set with the set criteria. Set [Sensitivity] to [AUTO] in the Fn menu. (p.117)
- Set the aperture to the **A** position while holding down the auto-lock button when using a lens with an aperture ring.

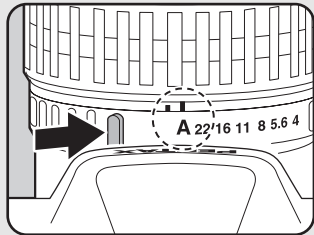

Exposure Warning

If the subject is too bright or too dark, the shutter speed will blink in the viewfinder and on the LCD panel. If the subject is too bright, set the aperture smaller (larger number), and when too dark, open the aperture further (smaller number). Once blinking stops, you can take the picture. If both the shutter speed and aperture value are blinking, this indicates being out of metering range and the proper exposure cannot be obtained even if the aperture is adjusted. Use an ND (Neutral Density) filter if the subject is too bright. Use a flash if it is too dark.



Using M (Manual) Mode

You can set the shutter speed and aperture value. This mode is suitable to take pictures of your choice by combining them. This mode is convenient for taking pictures using the same shutter speed and aperture setting combination or taking intentionally underexposed (darker) or overexposed (brighter) photographs.

☞ Effect of Aperture and Shutter Speed (p.130)

1 Set the mode dial to M.

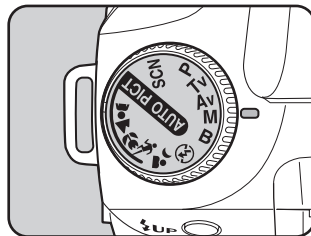

2 Turn the e-dial and adjust the shutter speed.

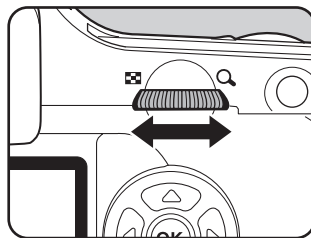

3 Turn the e-dial while pressing the \square Av button and adjust the aperture.

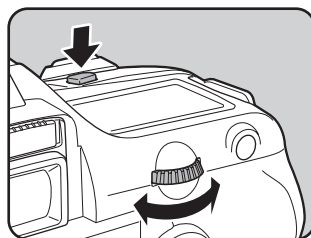

The shutter speed and aperture value are displayed in the viewfinder and on the LCD panel. Of the shutter speed and aperture value, the value being adjusted is underlined in the viewfinder. While adjusting the shutter speed or aperture value, the difference from the appropriate exposure (EV value) appears at the bottom right of the viewfinder. The appropriate exposure is set when [0.0] is displayed.



Difference from the appropriate exposure



- When in **M** (Manual) mode, the sensitivity is equivalent to ISO 200 when sensitivity is set to [AUTO].
- The viewfinder indicator blinks when the difference from appropriate exposure is over ± 3.0 .
- Set the shutter speed and aperture values in increments of 1/2 EV or 1/3 EV. Set in [Expsr Setting Steps] in the [**C** Custom Setting] menu. (p.144)
- Set the aperture to the **A** position while holding down the auto-lock button when using a lens with an aperture ring.

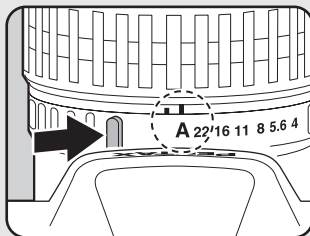

Exposure Warning

You are out of the measuring area if the shutter speed and aperture value blink. Use an ND (Neutral Density) filter if the subject is too bright. Use a flash if it is too dark.



About the AE-L Button

The aperture and shutter speed are automatically adjusted to the appropriate exposure at that moment if the **AE-L** button is pressed in **M** (Manual) mode. You can choose from the following three adjustment methods in [AE-L btn on M exspr] in the [**C** Custom Setting] menu.

| | | |
|---|--------------|---|
| 1 | Program Line | The aperture and shutter speed are adjusted automatically. |
| 2 | Tv Shift | The aperture is locked and the shutter speed is adjusted automatically. |
| 3 | Av Shift | The shutter speed is locked and the aperture is adjusted automatically. |

Shutter speed is adjusted to appropriate exposure according to lens aperture when lens aperture is not set to **A** position.

☞ Notes on [Using Aperture Ring] (p.184)

5

Using the B (Bulb) Mode

This mode is useful for the long exposures required for shooting night scenes and fireworks.

The shutter remains open as long as the shutter release button is kept pressed.

1 Set the mode dial to **B**.

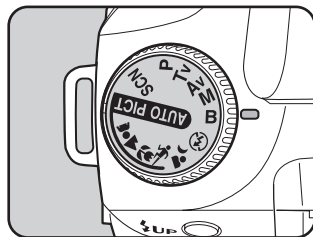

- Turn the e-dial to adjust the aperture value.
- Set the aperture value in increments of 1/2 EV or 1/3 EV. Set in [Exspr Setting Steps] in the [**C** Custom Setting] menu. (p.144)
- Use a sturdy tripod and the cable switch CS-205 (optional) to prevent camera shake when using **B** (Bulb) mode. Connect the cable switch to the cable switch terminal (p.15).
- Bulb shooting is available when using the remote control shooting mode (p.61). The shutter remains open as long as the optional remote control's shutter release button is held down.
- Noise reduction is a process to reduce noise (image roughness or unevenness) caused by low shutter speed. Set in [Noise Reduction] in the [**C** Custom Setting] menu. (p.102)
- When in **B** (Bulb) mode, the sensitivity is equivalent to ISO 200 when sensitivity is set to [AUTO].

Setting the Exposure

This allows you to deliberately overexpose (brighten) or under-expose (darken) your picture. You can adjust the EV Compensation from -2 to $+2$ (EV) in increments of $1/2$ EV or $1/3$ EV.

Set in [Expsr Setting Steps] in the [**C** Custom Setting] menu. (p.144)

- 1 **Set the compensation with the e-dial while the  Av button is pressed.**

 Av button

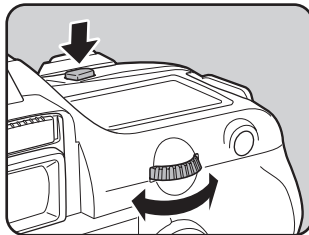

- 2 **Confirm the compensation value in the viewfinder.**



Compensation value

 is displayed during compensation.

 blinks when the flash is popped up if the flash compensation is set.



Exposure compensation is not available when the exposure mode is set to **M** (Manual) or **B** (Bulb) mode.



The exposure compensation cannot be canceled by turning the camera off or by setting any other exposure mode.

Changing the Exposure Setting Steps

Set Exposure Setting Steps in [Expsr Setting Steps] in [**C** Custom Setting] to increments of 1/2 EV or 1/3 EV.

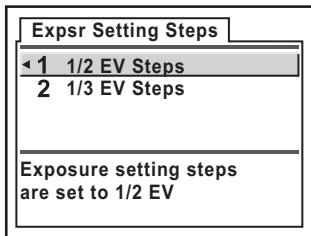

Recording the Exposure Before Shooting (AE Lock)

AE Lock is a function that memorizes the exposure prior to taking the picture. Use this when the subject is too small or backlit and a proper exposure setting cannot be obtained.

5

Function Reference

1 Press the **AE-L** button.

The camera memorizes the exposure (brightness) at that instant. Press it again to unlock.

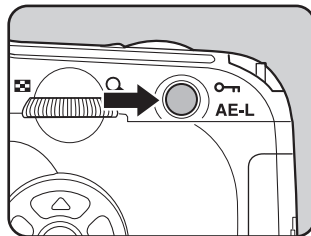

- ***** is displayed in the viewfinder while the AE lock is engaged. (p.20)
- The exposure remains in memory for twice as much time as the metering after releasing the **AE-L** button. The exposure remains locked as long as the **AE-L** button is kept pressed or the shutter release button is kept halfway.

• The camera beeps when the **AE-L** button is pressed. The beep can be turned off. (p.166)

• AE-L is not available when the exposure mode is **M** (Manual) or **B** (Bulb) mode. In **M** mode, the combination of shutter speed and aperture value changes depending on the zoom position even while the AE lock is engaged when using a zoom lens. In **B** mode, the maximum aperture varies depending on the focal length. However, the exposure value does not change and the picture is taken at the brightness level set by the AE lock.

• In **M** mode, the aperture and/or shutter speed are automatically adjusted to set the appropriate exposure when the **AE-L** button is pressed. (p.142)

- Exposure can be fixed when focus is locked. Set in [AE-L with AF locked] in the [**C** Custom Setting] menu. (p.127)

Changing the Exposure and Shooting (Auto Bracket)

You can take continuous pictures with different exposure when the shutter release button is pressed. The first frame is exposed with no compensation, the second frame is underexposed (negative compensation) and the third is overexposed (positive compensation).



Normal exposure



Underexposure

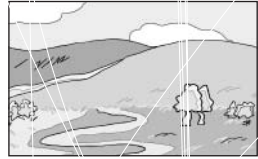

Overexposure

1 Press the Fn button in Capture mode.

The Fn menu appears.

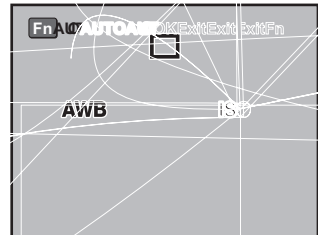

2 Press the four-way controller (▲).

The Drive Mode options screen appears.

3 Use the four-way controller (◀) to select (Auto Bracket).

4 Press the OK button.

The camera returns to the Fn menu screen.

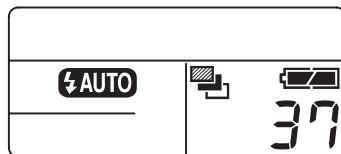

5 Press the Fn button.

Shooting is ready and  is displayed on the LCD panel.

6 Press the shutter release button halfway.

Focus indicator  appears in the viewfinder when focused.

7 Press the shutter release button fully.

Three continuous pictures will be taken, the first with no compensation, the second with negative compensation, and the third with positive compensation.



- When the [AF Mode] in the  Rec. Mode] is set to **AFS** (Single mode), the focus is locked in the first frame position and used for subsequent continuous frames.
- When you release your finger from the shutter release button during auto bracketing, the auto bracketing exposure setting will remain effective for twice as much time as the exposure metering timer (default setting is 20 seconds) (p.133) and you can take a picture at the next compensation value. In this case, auto focusing works for each frame. After about twice as much time as the exposure metering timer (default setting is 20 seconds), the camera returns to settings for taking the first picture.
- You can combine Auto Bracket with the built-in flash or external flash (P-TTL auto only) to change only the flash output continuously. However, when using an external flash, holding the shutter release button down to take three continuous frames may cause the second and third frame to be taken before the flash is fully recharged. Always take one frame at a time after confirming that charging is complete.
- Auto Bracket is not available when the exposure mode is set to **B** (Bulb) mode.

Setting Auto Bracket

Change the shooting order and steps of Auto Bracket.

| | | |
|-------------------------------------|--------|------------------------------------|
| Bracketng amount (Step interval) | 1/2 EV | ±0.5, ±1.0, ±1.5, ±2.0 |
| | 1/3 EV | ±0.3, ±0.7, ±1.0, ±1.3, ±1.7, ±2.0 |
| Shooting images | | 0 → - → +, - → 0 → +, + → 0 → - |

* Set interval of steps in [Expsr Setting Steps] in the [C Custom Setting] menu. (p.144)

Set in [Auto Bracket] in the [📷 Rec. Mode] menu. (p.100)

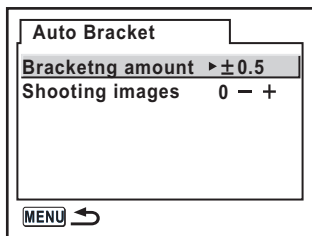

Taking Only Overexposed or Underexposed Pictures

You can use the auto bracketing mode for only underexposure or overexposure shots by combining the operation with exposure compensation (p.143). The auto bracketing is performed in both cases on the basis of the specified exposure compensation value.

Checking the Composition, Exposure and Focus Before Shooting

You can use the preview function to check the depth of field, composition, exposure and focus before taking a picture. There are 2 preview methods.

| | |
|-----------------|--|
| Digital Preview | For checking the composition, exposure and focus in the LCD monitor. |
| Optical Preview | For checking the depth of field with the viewfinder. |

Select the preview method in [Preview Method] in the [C Custom Setting] menu (p.103). The default setting is Digital Preview.

Displaying the Preview

Display the digital preview or optical preview.

5

Function Reference

Displaying the Digital Preview

- Focus on the subject, then compose the picture in the viewfinder and move the main switch to .**

The  icon appears in the LCD monitor during preview and you can check the composition, exposure and focus.

Press the shutter release button halfway to end Digital Preview and start focusing. The image displayed in Digital Preview is not saved.

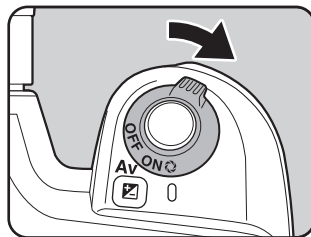

- You can display the overexposed area warning or histogram in Digital Preview. Set in [Preview Display] (p.174) in the [▶ Playback] menu.
- The maximum display time for Digital Preview is 60 seconds.

Displaying the Optical Preview

- 1 Position the subject inside the AF frame and press the shutter release button halfway.

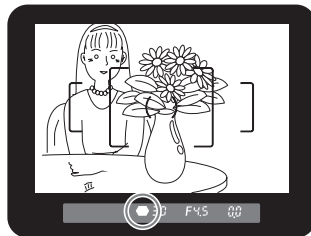

- 2 Turn the main switch to  while looking through the viewfinder.

You can check the depth of field in the viewfinder while the main switch is on .

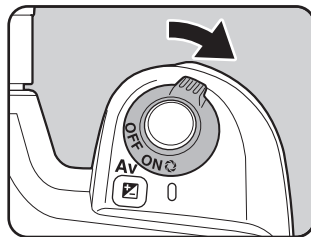

- No shooting information is displayed in the viewfinder, and the shutter cannot be released while the main switch is in the preview position (.
- You can check the depth of field in all exposure modes.

Selecting the Preview Method

Choose the preview method to use when the main switch is turned to the preview position (). The default setting is Digital Preview.

| | |
|-----------------|--|
| Digital Preview | For checking the composition, exposure and focus in the LCD monitor before taking a picture. |
| Optical Preview | For checking the depth of field with the viewfinder. |

Set in [Preview Method] in the [**C** Custom Setting] menu. (p.103)

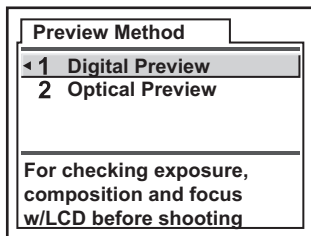

Using the Built-in Flash

You can change the flash output in a range of -2.0 to $+1.0$. The Flash Compensation values are as follows for $1/2$ EV and $1/3$ EV.

Allowing Shooting while Charging Flash

You can set to enable shooting while flash is being charged. Set [On] for [Release when Chrging] in the [C Custom Setting] menu (p.103). Pictures cannot be taken while the flash is charging by default.

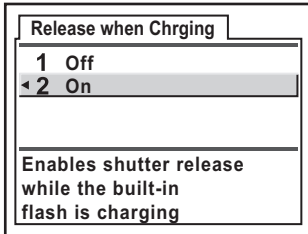

Flash Characteristics in Each Exposure Mode

5

Function Reference

Using the Flash in Tv (Shutter Priority) Mode

- When taking a moving subject, you can use the flash to change the blur effect.
- Any desired shutter speed 1/180 sec. or slower can be set for taking a flash photograph.
- The aperture value automatically changes according to the ambient brightness.
- The shutter speed is fixed at 1/180 sec. when lens other than DA, D FA, FA J, FA, F or A is used.

Using the Flash in Av (Aperture Priority) Mode

- You can set the desired aperture to take a flash photograph when you want to change the depth of field or shoot a subject farther away.
- The shutter speed automatically changes with the ambient brightness.
- The shutter speed shifts automatically anywhere from 1/180 sec. to a slow shutter speed (p.42) that reduces camera shake. The slowest shutter speed depends on the focal length of the lens in use.
- The shutter speed is fixed at 1/180 sec. when lens other than DA, D FA, FA J, FA or F is used.

Using Slow-Speed-Sync

You can use slow-speed-sync when shooting portraits with the sunset in the background. Both the portrait and the background are captured beautifully.



- Slow-speed-sync slows the shutter speed. Use a tripod to avoid camera shake. The picture will also blur if the subject moves.
- Slow-speed-sync shooting can also be performed with an external flash.

● Using Tv (Shutter Priority) Mode

- 1 Set the mode dial to **Tv**.
Tv (Shutter Priority) mode is set.
- 2 Use the e-dial to set the desired shutter speed.
The background is not properly corrected if aperture value is blinking when shutter speed is set. Set the shutter speed so that aperture value does not blink.
- 3 Press the **⚡UP** button.
The flash pops up.
- 4 Take the picture.

● Using M (Manual) Mode

- 1 Set the mode dial to **M**.
M (Manual) mode is set.
- 2 Set the shutter speed (under 1/180 sec.) and aperture value to obtain correct exposure.
- 3 Press the **⚡UP** button.
The flash pops up.
In **M** (Manual) mode, you can raise the flash at any time prior to shooting.
- 4 Take the picture.

Distance and Aperture when Using the Built-in Flash

A set criteria is necessary between the guide number, aperture and distance when shooting with the flash.

Calculate and adjust the shooting conditions if flash is not sufficient.

Built-in flash guide number

| Sensitivity | Built-in flash guide number |
|-------------|-----------------------------|
| ISO 200 | 15.6 |
| ISO 400 | 22 |
| ISO 800 | 31 |
| ISO 1600 | 44 |
| ISO 3200 | 62 |

Calculating Shooting Distance from Aperture Value

The following equation calculates the distance of the flash for aperture values.

Maximum flash distance $L1 = \text{Guide number} \div \text{Selected aperture}$

Minimum flash distance $L2 = \text{Maximum flash distance} \div 5^*$

* The value 5 used in the formula above is a fixed value which applies only when using the built-in flash alone.

Example

When sensitivity is [ISO 200] and aperture value is F4

$L1 = 15.6 \div 4 = \text{approx. } 3.9 \text{ (m)}$

$L2 = 3.9 \div 5 = \text{approx. } 0.8 \text{ (m)}$

Therefore, the flash can be used in a range of about 0.8 m to 3.9 m.

The flash cannot be used when the distance is less than 0.7 m. When the flash is used at closer than 0.7 m, it causes vignetting in the picture corners, light is distributed unevenly and the picture may be over-exposed.

Calculating Aperture Value from Shooting Distance

The following equation calculates the aperture value for shooting distances.

Aperture value used $F = \text{Guide number} \div \text{Shooting distance}$

When sensitivity is [ISO 200] and shooting distance is 5.2 m, aperture value is:

$F = 15.6 \div 5.2 = 3$

If the resulting number (3, in the above example) is not available as a lens aperture, the smaller number that is closest (2.8, in the above example) is generally used.

DA, D FA , FA J, FA and F Lens Compatibility with the Built-in Flash

When using DA, D FA, FA J, FA and F lenses with the **K110D** without the hood, built-in flash compatibility is shown below.

Yes : Available

: Available depending on other factors

No : Unavailable due to vignetting

Following are evaluated without a hood.

| Lens Name | Compatibility |
|---|--|
| DA Fish-eye 10-17 mm F3.5-4.5ED (IF) | No |
| F Fish-eye 17-28 mm F3.5-4.5 | # Vignetting may occur if focal length is less than 20 mm. |
| DA12-24 mm F4ED AL | No |
| DA16-45 mm F4ED AL | # When the focal length is less than 28 mm or when the focal length is 28 mm and the shooting distance is less than 1 m, vignetting may occur. |
| FA J18-35 mm F4-5.6AL | Yes |
| DA18-55 mm F3.5-5.6AL | Yes |
| FA20-35 mm F4AL | Yes |
| FA24-90 mm F3.5-4.5AL (IF) | Yes |
| FA28-70 mm F4AL | Yes |
| FA★28-70 mm F2.8AL | # Vignetting may occur if focal length is 28 mm and the shooting distance is less than 1 m. |
| FA J28-80 mm F3.5-5.6 | Yes |
| FA28-80 mm F3.5-5.6 | Yes |
| FA28-90 mm F3.5-5.6 | Yes |
| FA28-105 mm F4-5.6 | Yes |
| FA28-105 mm F4-5.6 (IF) | Yes |
| FA28-105 mm F3.2-4.5AL (IF) | Yes |
| FA28-200 mm F3.8-5.6AL (IF) | Yes |
| FA35-80 mm F4-5.6 | Yes |
| DA50-200 mm F4-5.6ED | Yes |
| FA70-200 mm F4-5.6 | Yes |

| Lens Name | Compatibility |
|----------------------------|---|
| FA J75-300 mm F4.5-5.8AL | Yes |
| FA★80-200 mm F2.8ED (IF) | Yes |
| FA80-320 mm F4.5-5.6 | Yes |
| FA80-200 mm F4.7-5.6 | Yes |
| FA100-300 mm F4.7-5.8 | Yes |
| FA★250-600 mm F5.6ED (IF) | No |
| DA14 mm F2.8ED (IF) | No |
| FA20 mm F2.8 | Yes |
| FA★24 mm F2AL (IF) | Yes |
| FA28 mm F2.8AL | Yes |
| FA31 mm F1.8AL Limited | Yes |
| FA35 mm F2AL | Yes |
| DA40 mm F2.8 Limited | Yes |
| FA43 mm F1.9 Limited | Yes |
| FA50 mm F1.4 | Yes |
| FA50 mm F1.7 | Yes |
| FA77 mm F1.8 Limited | Yes |
| FA★85 mm F1.4 (IF) | Yes |
| FA135 mm F2.8 (IF) | Yes |
| FA★200 mm F2.8ED (IF) | Yes |
| FA★300 mm F2.8ED (IF) | No |
| FA★300 mm F4.5ED (IF) | Yes |
| FA★400 mm F5.6ED (IF) | Yes |
| FA★600 mm F4ED (IF) | No |
| D FA Macro 50 mm F2.8 | Yes |
| D FA Macro 100 mm F2.8 | Yes |
| FA Macro 50 mm F2.8 | Yes |
| FA Macro 100 mm F2.8 | Yes |
| FA Macro 100 mm F3.5 | Yes |
| FA★ Macro 200 mm F4ED (IF) | Yes |
| FA Soft 28 mm F2.8 | # Built-in flash always discharges fully. |
| FA Soft 85 mm F2.8 | # Built-in flash always discharges fully. |

Using an External Flash (Optional)

Using the optional external flash AF540FGZ or AF360FGZ enables a variety of flash modes, such as P-TTL auto flash mode, high-speed flash sync mode, and wireless mode. See the chart below for details.

(Yes: Available #: Restricted No: Not available)

| Camera Function \ Flash | Built-in Flash | AF540FGZ AF360FGZ |
|---|-------------------|----------------------|
| Red-eye reduction flash | Yes | Yes |
| Automatic flash discharge | Yes | Yes |
| After the flash is charged, the camera automatically switches to the flash sync speed. | Yes | Yes |
| Aperture is automatically set in P (Program) mode and Tv (Shutter Priority) mode. | Yes | Yes |
| Auto check in the viewfinder | No | No |
| P-TTL auto flash (appropriate sensitivity: 200 to 3200) | Yes* ¹ | Yes* ¹ |
| Slow-speed sync | Yes | Yes |
| Flash Exposure Compensation | Yes | Yes |
| AF illuminator | Yes | Yes |
| Rear curtain sync flash* ² | #* ³ | Yes |
| Contrast-control-sync flash mode | #* ⁴ | Yes |
| Slave flash | No | Yes |
| Multiple flash | No | No |
| High-speed flash sync | No | Yes |
| Wireless flash* ⁵ | No | Yes |

*1 When using DA, D FA, FA J, FA, F or A lens.

*2 Shutter speed of 1/90 sec. or slower.

*3 Can be combined with AF540FGZ or AF360FGZ for rear curtain sync flash.

*4 When combined with the AF540FGZ or AF360FGZ, 1/3 of the flash discharge can be output by the built-in flash and 2/3 can be output by the external flash.

*5 Two or more AF540FGZ or AF360FGZ units are required.

About the LCD Panel Display for AF360FGZ

The AF360FGZ does not have the function to set the FORMAT size to [DIGITAL], but the difference in angle of view between standard 35-mm format and the **K110D** is automatically calculated based on the focal length of the lens used (when using DA, D FA, FA J, FA or F lenses). The conversion indicator appears and the format size indicator disappears when the exposure metering timer of the **K110D** is on (it returns to 35 mm format display when the exposure metering timer is turned off).

| Lens focal length | | 85mm | 77mm | 50mm | 35mm | 28mm | 24mm | 20mm | 18mm |
|-----------------------|-----------------------------------|------|------|------|------|------|------|------|-------|
| AF360FGZ LCD panel | Exposure metering timer Off | 85mm | 70mm | 50mm | 35mm | 28mm | 24mm | 20mm | 18mm* |
| | Exposure metering timer On | 58mm | 48mm | 34mm | 24mm | 19mm | 16mm | 14mm | 12mm* |

* Using wide-angle panel

Using P-TTL Auto Mode

Use this flash mode with the AF540FGZ or AF360FGZ flash unit. When flash mode is set to [P-TTL auto], the flash pre-fires right before taking pictures using 16-segment metering and allows more precise control. P-TTL auto is available in wireless flash mode when two or more AF540FGZ or AF360FGZ units are used.

- 1 Remove the cover of the hot shoe and attach the external flash (AF540FGZ or AF360FGZ).
- 2 Turn on the camera and the external flash.
- 3 Set the external flash mode to [P-TTL auto].
- 4 Confirm that the external flash is fully charged and then take the picture.



- P-TTL auto is only available with the AF540FGZ or AF360FGZ flash unit.
- The will light in the viewfinder when the flash is ready (fully charged).
- For details such as operation method and effective distance, please read the external flash manual.
- The flash does not discharge when the subject is bright enough when Flash Mode is or . Therefore, it may not be suitable for daylight-sync shooting.
- Never press the flash pop up button when any external flash unit is attached to the camera. The built-in flash will hit the external flash. If you want to use both at once, see p.160 for the connection method.

Using High-Speed Flash Sync Mode

With the AF540FGZ or AF360FGZ, you can discharge the flash to take a picture at a shutter speed faster than 1/180 second. High-speed flash sync can be used with the flash attached to the camera, or wireless.

Attaching and Using the AF540FGZ or AF360FGZ on the Camera

- 1 Remove the cover of the hot shoe and attach the external flash (AF540FGZ or AF360FGZ).
- 2 Turn the mode dial and set the exposure mode to **Tv** or **M**.
- 3 Turn on the camera and the external flash.
- 4 Set the external flash sync mode to HS  (high-speed flash sync).
- 5 Confirm that the external flash is fully charged and then take the picture.



- The  will light in the viewfinder when the flash is ready (fully charged).
- High-speed flash sync is only available when the shutter speed is faster than 1/180 sec.
- High-speed flash sync is not available when the exposure mode is set to **B** (Bulb).

5

Function Reference

Using in Wireless Mode

You can shoot using the flash without connecting the camera and flash with a cord by using two external flashes (AF540FGZ or AF360FGZ). The High-speed sync mode is also available in wireless mode.



Be sure to set the two external flashes (AF540FGZ or AF360FGZ) to the same channel. See the AF540FGZ or AF360FGZ operating manual for details.

● Using in Wireless Mode

- 1 Place the external flash (AF540FGZ or AF360FGZ) at the desired location.
- 2 Set the power switch of the above external flash to [WIRELESS].
- 3 Set the wireless mode of the above external flash to [S] (Slave).
- 4 Turn on the camera, and then turn the mode dial and set the exposure mode to **P**, **Tv**, **Av** or **M**.
- 5 Set the power switch of the external flash on the camera to [WIRELESS].
- 6 Set the wireless mode of the external flash on the camera to **M** (Master) or **C** (Control).



- Wireless mode is not available for the built-in flash.
- Set the wireless slave mode of the external flash to [SLAVE1].

Wireless Flash Control (P-TTL Flash Mode)

The following information is exchanged between the two external flash units (AF540FGZ or AF360FGZ) before the flash is discharged when the external flash units are used for wireless flash.

Press the shutter release button fully.

- 1 The flash unit on the camera emits a small control flash (relays the flash mode of the camera).
- 2 The external wireless flash unit emits a small control flash (relays confirmation of subject).
- 3 The flash unit on the camera emits a small control flash (relays flash output of external wireless flash unit).
 - * The flash unit on the camera will emit a small control flash one more time after this to relay the flash duration time when HS  (High-speed sync) is set.
- 4 The external flash unit(s) discharges as main flash.



Set the wireless slave mode of the external flash to [SLAVE1].

Red-Eye Reduction

As with the built-in flash, red-eye reduction is available with an external flash. This may not be available on some flashes or may have restrictions for usage conditions. See the chart on p.156.



- The red-eye reduction feature works even when only an external flash is used. (p.54)
- If red-eye reduction is used when the external flash is set as the slave unit or with the wireless function, the preflash for red-eye reduction will trigger the external flash. Do not use red-eye reduction when using a slave unit.

Rear Curtain Sync Flash

When using the built-in flash with an external flash (AF540FGZ or AF360FGZ) that is set to the rear curtain flash function, the built-in flash will also use this mode. Confirm that both flash units are fully charged before shooting.

Using the Built-in Flash with the External Flash

As shown in the figure below, attach the hot shoe adapter F₆ (optional) to the camera hot shoe and an off-camera shoe adapter F (optional) to the bottom of the external flash, and connect these with the extension cord F5P (optional). The off camera shoe adapter F comes with a tripod screw for securing to your tripod.

Only the P-TTL auto flash can be used in combination with the built-in flash.

When combining with the built-in flash

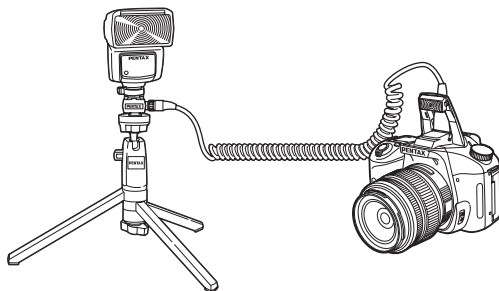

Discharging Multiple Flashes

You can combine two or more external flashes (AF540FGZ or AF360FGZ) or you can use an external flash in combination with the built-in flash. You can use the extension cord connection terminal on the flash to connect the AF540FGZ. You can connect AF360FGZ units as shown in the illustration below. Connect an external flash and the Hot Shoe Adapter F (optional) to the Off-Camera Shoe Adapter F (optional) and then connect another Off-Camera Shoe Adapter F with external flash using the Extension Cord F5P (optional). Refer to the flash manual for details.



- Do not combine with accessories that have a different number of contacts such as a Hot Shoe Grip. A malfunction may occur.
- Combining with flashes from other manufacturers may cause equipment breakdown. We recommend using the AF540FGZ or AF360FGZ.

When combining two or more external flashes

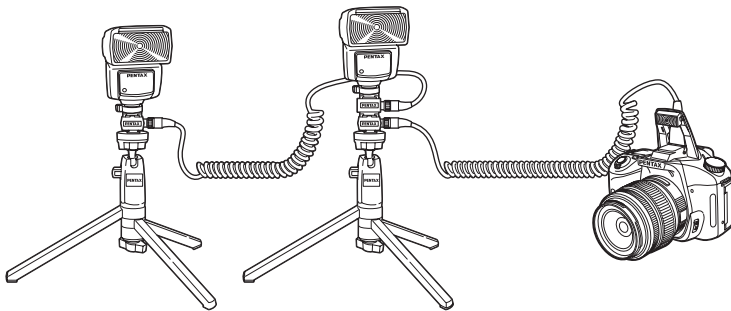

When using multiple external flashes or an external flash with the built-in flash, P-TTL is used for flash control.

Contrast-Control-Sync Flash

Combining two or more external flashes (AF540FGZ or AF360FGZ) or using an external flash in combination with the built-in flash allows multiple flash photography (contrast-control-sync flash photography). This is based on the difference between the amounts of light discharged from multiple units.



- Do not combine with accessories that have a different number of contacts such as a Hot Shoe Grip as a malfunction may occur.
- Combining with flashes from other manufacturers may cause equipment breakdown. We recommend using PENTAX automatic flashes.

- 1 Connect the external flash to the camera indirectly. (p.160)
- 2 Set the sync mode for the external flash to the Contrast-Control-Sync mode.
- 3 Turn the mode dial and set the exposure mode to **P**, **Tv**, **Av** or **M**.
- 4 Confirm that both the external flash and built-in flash are fully charged and then take the picture.



- When using two or more external flashes and the Contrast-Control-Sync mode is set on the external master flash unit, the flash output ratio is 2 (master unit) : 1 (slave units). When external flash is used in combination with the built-in flash, the flash output ratio is 2 (external flash) : 1 (built-in flash).
- When using multiple external flashes or an external flash with the built-in flash, P-TTL is used for flash control.
- The fastest flash synchronization speed is 1/180 second in the Contrast-Control-Sync mode.

Changing Playback Display Method

Sets the information to show first during playback and whether to display overexposed area warning.

The camera switches display information when you press the **INFO** button.

1 Select [Plybk dsply mthd] on the [▶ Playback] menu.

2 Press the four-way controller (⬇️).

The screen for setting the playback display method appears.

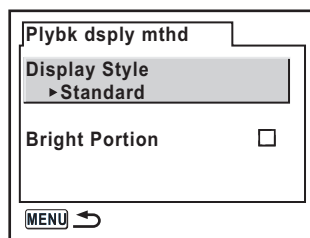

3 Use the four-way controller (⬆️) to select [Display Style].

4 Use the four-way controller (⬅️) to select the information to show.

| | |
|------------------|--|
| Standard | Captured image and indicators are displayed. |
| Histogram | Images and histogram are displayed. |
| Detailed Info | Shooting information appears with a small image in the upper left. |
| No info. Display | Only captured images are displayed. |
| Last memory | Display settings are retained from previous session. |

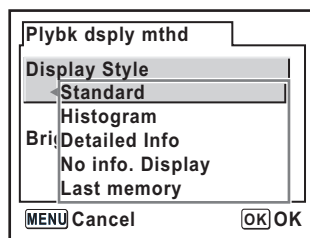

5 Press the OK button.

The selected information setting is saved.

6 Use the four-way controller (⏏) to select [Bright Portion].**7 Use the four-way controller (⏏) to select (On) or (Off).****8 Press the MENU button twice.**

The camera is ready to take a picture.



Refer to p.18 for various display information details.

5

Setting the Slideshow Display Interval

You can play back all images recorded on your SD Memory Card successively. (p.70)

Set image display interval to [3 sec], [5 sec], [10 sec] or [30 sec]. The default setting is [3 sec].

Set in [Slideshow] in the [Playback] menu (p.100).

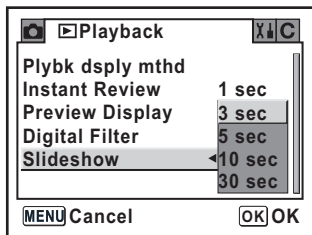

After setting, press the **OK** button to start slideshow.

Formatting the SD Memory Card

Be sure to format new SD Memory Card with the camera before using the card.

Formatting will delete all the data on the SD Memory Card.



- Do not open the card cover while formatting SD Memory Card. The card may be damaged beyond use.
- Formatting will delete protected data. Be aware.

1 Select [Format] on the [X↓ Set-up] menu (p.101).

2 Press the four-way controller (⏮) to display the Format screen.

3 Use the four-way controller (⏮) to select [Format].

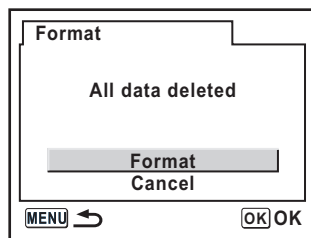

4 Press the OK button.

Formatting starts. When formatting is completed, the camera is ready to take pictures.

Turning the Beep On and Off

You can turn the camera operation beep on or off. The default setting is (On) .

Set in [Beep] in the [X Set-up] menu. (p.101)

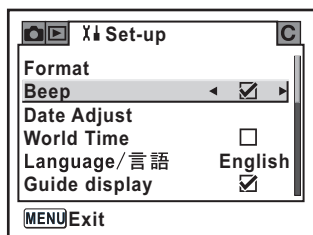

5

Changing the Date and Time and the Display Style

You can change the initial date and time settings. You can also set the display style. Choose [mm/dd/yy], [dd/mm/yy] or [yy/mm/dd]. Choose [12h] (12 hour) or [24h] (24 hour) for time display method.

☞ Setting the Date and Time (p.35)

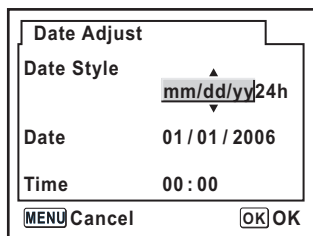

Setting the World Time

The date and time selected in “Initial Settings” (p.33) serve as the date and time of your present location.

Setting [World Time] enables you to display the local date and time on the LCD monitor when traveling overseas.

1 Select [World Time] on the [X↓ Set-up] menu. (p.101)

2 Press the four-way controller (⤴).

The World Time screen appears.

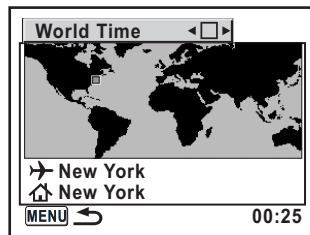

3 Use the four-way controller (⤴⤵) to select (On) or (Off).

| | |
|-------------------------------------|---|
| <input checked="" type="checkbox"/> | Applies time of city set in → (Destination) |
| <input type="checkbox"/> | Applies time of city set in ⤴ (Hometown) |

4 Press the four-way controller (⤵).

The selection frame moves to →. The city with → blinks.

5 Press the four-way controller (⤴).

The screen for magnifying the Destination region appears.

Use the four-way controller (⤴⤵) to change the region to magnify.

6 Press the four-way controller (⤵).

The frame moves to city.

7 Use the four-way controller (⬅️➡️) to select the Destination city.

The current time, location and time difference of the selected city appears.

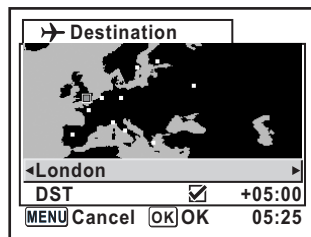

8 Use the four-way controller (⬅️) to select [DST].

9 Use the four-way controller (⬅️➡️) to select (On) or (Off).

Select (On) if the Destination city uses daylight saving time (DST).

10 Press the OK button.

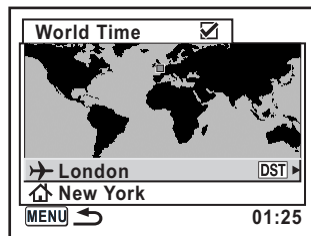

The World Time setting is saved.
To continue with World Time setting operations, press the **OK** button to return to the World Time screen.



11 Press the MENU button twice.

The camera is ready to take pictures.



- See "List of World Time Cities" (p.169) for cities that can be specified as a destination.
- Select  in Step 4 to set the city and DST setting.
-  appears on the guide display screen if World Time is On (). (p.16)

List of World Time Cities

| Region | City | Region | City |
|---------------------------|----------------|----------------------|--------------|
| North America | Honolulu | Africa/ West Asia | Nairobi |
| | Anchorage | | Jeddah |
| | Vancouver | | Tehran |
| | San Francisco | | Dubai |
| | Los Angeles | | Karachi |
| | Calgary | | Kabul |
| | Denver | | Male |
| | Chicago | | Delhi |
| | Miami | | Colombo |
| | Toronto | | Kathmandu |
| | New York | | Dacca |
| | Halifax | | |
| Central and South America | Mexico City | East Asia | Yangon |
| | Lima | | Bangkok |
| | Santiago | | Kuala Lumpur |
| | Caracas | | Vientiane |
| | Buenos Aires | | Singapore |
| | Sao Paulo | | Phnom Penh |
| | Rio de Janeiro | | Ho chi Minh |
| | | | Jakarta |
| Europe | Madrid | | Hong Kong |
| | London | | Beijing |
| | Paris | | Shanghai |
| | Amsterdam | | Manila |
| | Milan | | Taipei |
| | Rome | | Seoul |
| | Berlin | | Tokyo |
| | Stockholm | | Guam |
| | Athens | | |
| | Helsinki | Oceania | Perth |
| | Moscow | | Adelaide |
| | | | Sydney |
| Africa/ West Asia | Dakar | | Noumea |
| | Algiers | | Wellington |
| | Johannesburg | | Auckland |
| | Istanbul | | Pago Pago |
| | Cairo | | |
| | Jerusalem | | |

Setting the Display Language

You can change the language in which the menus, error messages, etc. are displayed.

Set in [Language/言語] in the [X↓ Set-up] menu. (p.101)

You can choose from eleven languages: English, French, German, Spanish, Italian, Swedish, Dutch, Russian, Korean, Chinese (Traditional/Simplified) and Japanese.

☞ Setting the Display Language (p.33)

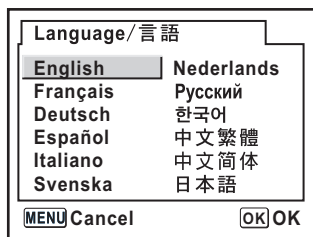

Turning the Guide Display On and Off

Set to display guides on the LCD monitor when main switch is on or exposure mode is changed. (p.16)

| | |
|-------------------------------------|-------------------|
| <input checked="" type="checkbox"/> | Guide display on |
| <input type="checkbox"/> | Guide display off |

Set in [Guide display] in the [X↓ Set-up] menu. (p.101)

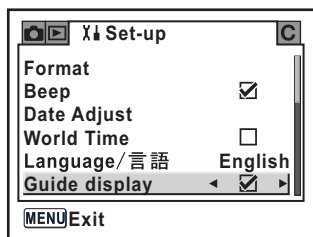

Adjusting the Brightness of the LCD Monitor

You can adjust the brightness of the LCD monitor. Adjust settings when the LCD monitor is hard to see.

Set in [Brightness Level] in the [**X** Set-up] menu. (p.101)

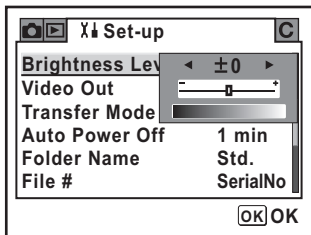

Selecting the Video Output Format

When you connect the camera to AV equipment such as a TV, choose the appropriate video output format (NTSC or PAL) for playing back images. Set in [Video Out] in the [**X** Set-up] menu. (p.101)

☞ Connecting the Camera to AV Equipment (p.72)

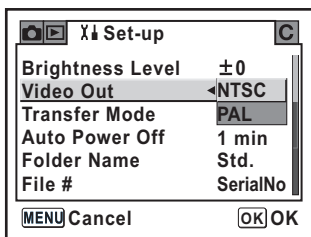

The video output format varies according to region. The video output format used in North America is NTSC.

Setting Auto Power Off

You can set the camera to turn off automatically if unused after a certain length of time. Select from [1 min], [3 min], [5 min], [10 min], [30 min] or [Off]. The default setting is [1 min].

Set in [Auto Power Off] in the [**X** Set-up] menu. (p.101)

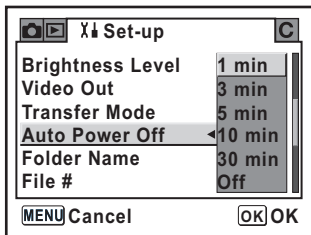

Auto Power Off will not work during slideshow playback, a USB connection, remote control shooting or while displaying menu or Fn menu.

5

Selecting the Folder Name

You can select the method for assigning the folder names for storing images. The default setting is [Std.].

| | |
|------|---|
| Std. | The folder name is assigned in the form of [xxxPENTX]. [xxx] is a sequential number from 100 to 999. (Example) 101PENTX |
| Date | The two digits of the [month] and [day] on which the picture was taken are assigned as the folder name in the form of [xxx_MMDD]. (Example) 101_0125 : for folders with pictures taken on January 25th |

Set in [Folder Name] in the [**X** Set-up] menu. (p.101)

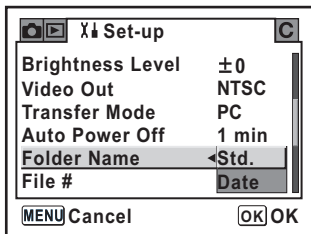

Resetting the File Number

You can set the file number used for the images when inserting a new SD Memory Card. The default setting is [SerialNo].

Set in [File #] in the [X↓ Set-up] menu. (p.101)

You can perform the settings related to Instant Review and Digital Preview.

Select from [1 sec], [3 sec], [5 sec] or [Off]. The default setting is [1 sec].
Set in [Instant Review] in the [▶ Playback] menu. (p.100)

Displaying Histogram and Bright Portion

Set to display histogram and bright portion during Instant Review and Digital Preview.

Set in [Preview Display] in the [▶ Playback] menu. (p.100) In the default setting, the histogram and overexposed area warning do not appear.

1 Select [Preview Display] in the [▶ Playback] menu.

2 Press the four-way controller (⬇️).

The screen for setting the Preview Display appears.

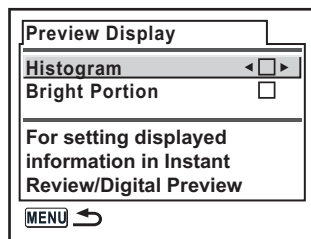

3 Use the four-way controller (⬅️) to select (On) or (Off) for [Histogram].

| | |
|-------------------------------------|---|
| <input checked="" type="checkbox"/> | The histogram is displayed in the Instant Review and Digital Preview screens. |
| <input type="checkbox"/> | The histogram is not displayed. |

4 Use the four-way controller (⬇️) to select [Bright Portion].

5 Use the four-way controller (⬅️) to select (On) or (Off).

| | |
|-------------------------------------|--|
| <input checked="" type="checkbox"/> | The overexposed area warning is displayed in the Instant Review and Digital Preview screens. |
| <input type="checkbox"/> | The overexposed area warning is not displayed. |

6 Press the MENU button twice.

The camera is ready to take a picture.

Settings in [📷 Rec. Mode] menu, [▶ Playback] menu and [⏏ Set-up] menu are reset to default settings. However, Date Adjust, Language, Video Out and World Time are not reset.

- 1** Select [Reset] on the [⏏ Set-up] menu.
- 2** Press the four-way controller (⏏) to display the [Reset] screen.
- 3** Use the four-way controller (⏏) to select [Reset].

Resetting the Custom Function Menu

Reset settings in [C Custom Setting] menu to default settings. Settings in [Rec. Mode] menu, [Playback] menu and [X Set-up] menu are not reset.

- 1 Select [Reset] on the [C Custom Setting] menu.
- 2 Press the four-way controller (⬇) and display the Reset Custom Fncion screen.
- 3 Use the four-way controller (⬆) to select [Reset].

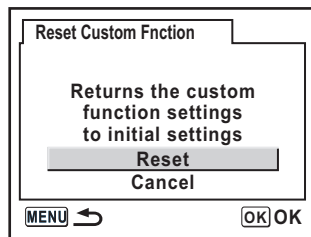

- 4 Press the OK button.

The camera is ready to take or play back images.

6 Appendix

| | |
|---|------------|
| Default Settings | 178 |
| Functions Available with Various Lens Combinations | 182 |
| Notes on [Using Aperture Ring] | 184 |
| Cleaning the CCD | 185 |
| Optional Accessories | 187 |
| Error Messages | 190 |
| Troubleshooting | 192 |
| Main Specifications | 195 |
| Glossary | 198 |
| Index | 202 |
| WARRANTY POLICY | 206 |

The table below lists the factory default settings.

Table notations are as follows.

Last Memory Setting

Yes : The current setting (last memory) is saved when the camera is turned off.

No : The setting returns to the default setting when the camera is turned off.

Reset Setting

Yes : The setting returns to the default setting with the reset function (p.175).

No : The setting is saved even after reset.

[📷 Rec. Mode] Menu

| Item | Default Setting | Last Memory Setting | Reset Setting | Page |
|------------------|-------------------------------|---------------------|---------------|-------|
| Image Tone | (Bright) | Yes | Yes | p.110 |
| Recorded Pixels | (3008x2000) | Yes | Yes | p.111 |
| Quality Level | ★★★ (Best) | Yes | Yes | p.112 |
| Saturation | (0) | Yes | Yes | p.113 |
| Sharpness | (0) | Yes | Yes | p.113 |
| Contrast | (0) | Yes | Yes | p.113 |
| Auto Bracket | ±0.5/0 - + | Yes | Yes | p.147 |
| AE Metering | (Multi-segment) | Yes | Yes | p.132 |
| Swthc dst msr pt | (Auto) | Yes | Yes | p.124 |
| AF Mode | A.F.S (Single mode) | Yes | Yes | p.123 |
| Flash Exp. Comp. | 0.0 | Yes | Yes | p.150 |

[▶ Playback] Menu

| Item | Default Setting | Last Memory Setting | Reset Setting | Page |
|------------------|-----------------|--------------------------------|---------------|-------|
| Plybk dsply mthd | Display Style | Standard | Yes | p.163 |
| | Bright Portion | <input type="checkbox"/> (Off) | Yes | |
| Instant Review | 1sec | Yes | Yes | p.173 |
| Preview Display | Histogram | <input type="checkbox"/> (Off) | Yes | p.174 |
| | Bright Portion | <input type="checkbox"/> (Off) | Yes | |

| Item | Default Setting | Last Memory Setting | Reset Setting | Page |
|----------------|-----------------|---------------------|---------------|------|
| Digital Filter | B&W | Yes* | Yes | p.73 |
| Slideshow | 3sec | Yes | Yes | p.70 |

* The slimness setting for the slim filter, the softness setting for the soft filter, the brightness setting for the brightness filter, and the color setting for the color filter are saved.

[X] Set-up] Menu

| Item | Default Setting | Last Memory Setting | Reset Setting | Page | |
|------------------|--|--------------------------------|---------------|-------|-------|
| Format | — | — | — | p.165 | |
| Beep | <input checked="" type="checkbox"/> (On) | Yes | Yes | p.166 | |
| Date Adjust | According to default setting | Yes | No | p.166 | |
| World Time | World Time setting | <input type="checkbox"/> (Off) | Yes | Yes | p.167 |
| | Hometown (City) | According to default setting | Yes | No | |
| | Hometown (DST) | According to default setting | Yes | No | |
| | Destination (City) | Same as Hometown | Yes | No | |
| | Destination (DST) | Same as Hometown | Yes | No | |
| Language/言語 | According to default setting | Yes | No | p.170 | |
| Guide display | <input checked="" type="checkbox"/> (On) | Yes | Yes | p.170 | |
| Brightness Level | 0 | Yes | Yes | p.171 | |
| Video Out | According to default setting | Yes | No | p.171 | |
| Transfer Mode | PC | Yes | Yes | p.86 | |
| Auto Power Off | 1min | Yes | Yes | p.172 | |
| Folder Name | Std. | Yes | Yes | p.172 | |
| File # | SerialNo | Yes | Yes | p.173 | |
| Sensor Cleaning | — | — | — | p.185 | |
| Reset | — | — | — | p.175 | |

[C Custom Setting] Menu

| Item | Default Setting | Last Memory Setting | Reset Setting | Page |
|----------------------|----------------------------------|---------------------|---------------|--------------|
| Settings | □ (Off) | Yes | Yes | p.102 |
| Noise Reduction | On | Yes | Yes | p.142 |
| Exprs Setting Steps | 1/2 EV Steps | Yes | Yes | p.144 |
| ISO Corction in AUTO | ISO 200-800 | Yes | Yes | p.117 |
| ISO Snstvty Wrn Dspl | Off | Yes | Yes | p.118 |
| Link AF Point and AE | Off | Yes | Yes | p.133 |
| Meter Operating Time | 10 sec | Yes | Yes | p.133 |
| AE-L with AF locked | Off | Yes | Yes | p.127 |
| Recordable Image No. | Remaining image storage capacity | Yes | Yes | p.102 |
| OK btn when shooting | Confirm Sensitivity | Yes | Yes | p.122, p.125 |
| AE-L btnn on M exprs | Program Line | Yes | Yes | p.142 |
| Superimpose AF Area | On | Yes | Yes | p.124 |
| AF in remote control | Off | Yes | Yes | p.103 |
| FI with S lens used | Not available | Yes | Yes | p.103 |
| Using aperture ring | Prohibited | Yes | Yes | p.184 |
| Release when Chrging | Off | Yes | Yes | p.151 |
| Preview Method | Digital Preview | Yes | Yes | p.149 |
| Mag to Strt Zm Plybk | 1.2 times | Yes | Yes | p.103 |
| Man. WB Measurement | Entire screen | Yes | Yes | p.115 |
| Color Space | sRGB | Yes | Yes | p.119 |
| Reset Custom Fncion* | — | — | — | p.176 |

* Reset settings in [C Custom Setting] menu.

Fn Menu

| Item | Default Setting | Last Memory Setting | Reset Setting | Page |
|-----------------|--|---------------------|---------------|----------------------------------|
| Drive Mode | <input type="checkbox"/> (Single frame shooting) | No*1 | Yes | p.55, p.57, p.61, p.145 |
| Flash Mode |  (Auto) | Yes | Yes | p.51 |
| White Balance | AWB (Auto) | Yes | Yes | p.114 |
| ISO Sensitivity | AUTO | Yes | Yes | p.117 |
| Scene Mode | Night Scene | Yes | Yes | p.47 |
| DPOF Settings | — | Yes | No | p.82 |
| Digital Filter | B&W | Yes*2 | Yes | p.73 |
| Slideshow | 3sec | Yes | Yes | p.70 |

*1 Only continuous shooting settings are saved.

*2 The slimness setting for the slim filter, the softness setting for the soft filter, the brightness setting for the brightness filter, and the color setting for the color filter are saved.

Functions Available with Various Lens Combinations

Lenses that can be used with this camera

Only DA and FA J lenses and D FA/FA/F/A lenses having an **A** position on the aperture ring can be used with this camera. Refer to “Notes on [Using Aperture Ring]” (p.184) for other lenses and D FA/FA/F/A lenses with aperture ring set to a position other than **A**.

| Function \ Lens[Mount type] | DA/D FA/ FA J/FA lens [KAF, KAF2] ^{*3} | F lens [KAF] ^{*3} | A lens [KA] |
|--|---|-------------------------------|------------------------|
| Autofocus (Lens only) (With AF adapter 1.7x) ^{*1} | Yes — | Yes — | — Yes ^{*5} |
| Manual focus (With the focus indicator) ^{*2} (With Matte field) | Yes Yes | Yes Yes | Yes Yes |
| Eleven AF points | Yes | Yes | No ^{*5} |
| Power zoom | No | — | — |
| Aperture Priority Auto Exposure | Yes | Yes | Yes |
| Shutter Priority Automatic Exposure | Yes | Yes | Yes |
| Manual Exposure | Yes | Yes | Yes |
| P-TTL Auto Flash ^{*4} | Yes | Yes | Yes |
| Multi (16-segment) metering | Yes | Yes | Yes |

Yes : Functions are available when the aperture ring is set to the **A** position.

No : Functions are unavailable.

*1 Lenses with a maximum aperture of f/2.8 or brighter. Only available at **A** position.

*2 Lenses with a maximum aperture of f/5.6 or brighter.

*3 To use an F/FA soft 85 mm f/2.8 lens or FA soft 28 mm f/2.8 lens, set [Using aperture ring] to [Permitted] in the [C Custom Setting] menu (p.102). Pictures can be taken with the aperture you set, but only within manual aperture range.

*4 When using the built-in flash and AF540FGZ or AF360FGZ.

*5 The AF point becomes  (Center).

Lens names and mount names

FA prime lenses (non-zoom lenses) and DA, D FA, FA J and F lenses use the KAF mount. Of the FA zoom lenses, power zoom enabled lenses use the KAF2 mount. Lenses without power zoom use the KAF mount. See the lens manual for details. This camera does not have a power zoom function.

Lenses and accessories that cannot be used with this camera

When aperture ring is set at other than **A** (Auto) or a lens without a **A** (Auto) position or accessories such as an auto extension tube or auto bellows are used, camera does not operate unless [Using aperture ring] is set to [Permitted] in the [**C** Custom Setting] menu (p.103). Refer to “Notes on [Using Aperture Ring]” (p.184) for restriction that apply when [Using aperture ring] is set to [Permitted] in the [**C** Custom Setting] menu. All camera exposure modes are available when using DA/FA J or lenses with Aperture **A** (Auto) position set to that position.

Lens and Built-in Flash

The built-in flash cannot be regulated and fully fires when pre A lenses or soft focus lenses are used.

Note that the built-in flash cannot be used as the Auto Flash.

Aperture Ring Use

When [Using aperture ring] is set to [Permitted] in [C Custom Setting] menu (p.103), the shutter can be released even if the aperture ring of the D FA, FA, F or A lens is not set to the **A** position or a lens without a **A** position is attached. However, the features will be restricted as shown in the table below.



The camera operates in **Av** (Aperture Priority) mode even if the mode dial is at **P** or **Tv** when the aperture is set to a value other than **A**.

| Lens used | Exposure mode | Restriction |
|--|------------------------------------|--|
| D FA, FA, F, A, M (lens only or with auto diaphragm accessories such as auto extension tube K) | Av (Aperture Priority) mode | The aperture remains open regardless of the aperture ring position. The shutter speed changes in relation to the open aperture but an exposure error may occur. In the viewfinder, [F--] appears for the aperture indicator. |
| D FA, FA, F, A, M, S (with diaphragm accessories such as extension tube K) | Av (Aperture Priority) mode | Pictures can be taken with the specified aperture value but an exposure error may occur. In the viewfinder, [F--] appears for the aperture indicator. |
| Manual diaphragm lens such as reflex lens (lens only) | Av (Aperture Priority) mode | |
| FA, F Soft 85mm FA Soft 28mm (lens only) | Av (Aperture Priority) mode | Pictures can be taken with the specified aperture value in the manual aperture range. In the viewfinder, [F--] appears for the aperture indicator. When depth of field is checked (Optical Preview), AE Metering is switched on. Exposure check is possible. |
| All lenses | M (Manual) mode | Pictures can be taken with the set aperture value and shutter speed. In the viewfinder, [F--] appears for the aperture indicator. When depth of field is checked (Optical Preview), AE Metering is switched on. Exposure check is possible. |

Shadows may appear in the image for white backgrounds and other shooting conditions if the CCD becomes dirty or dusty. This indicates that the CCD must be cleaned. Please contact PENTAX service center for professional cleaning because the CCD is a precision part.



- Do not use a spray type blower.
- Do not clean the CCD when the exposure mode is set to **B** (Bulb) mode.
- Always cap the lens mount area to prevent dirt and dust from accumulating on the CCD when no lens is on the camera.
- It is recommended to use the AC adapter when cleaning the CCD.
- When the battery level is low, [Not enough battery remaining to clean sensor] is displayed on the LCD monitor.
- If you are not using the AC adapter, please use batteries with ample capacity remaining. A warning beep will sound if the battery capacity becomes low during cleaning. Please stop cleaning immediately.
- Do not put the tip of the blower inside the lens mount area. If the power is turned off, this could cause damage to the shutter or the CCD sensor.



- Use of the AC adapter (optional) is recommended.
- The self-timer lamp blinks and [Cln] appears on the LCD panel while cleaning the CCD.

- 1 Turn the camera off and remove the lens.**
- 2 Turn the camera on.**
- 3 Select [Sensor Cleaning] on the [X↓ Set-up] menu.**
- 4 Press the four-way controller (⏏).**

The Sensor Cleaning screen appears.

- 5** Use the four-way controller (▲) to select [Mirror Up].

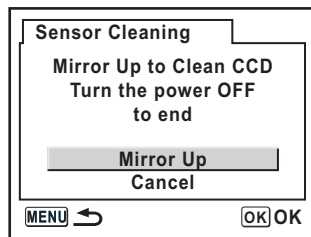

- 6** Press the **OK** button.

The mirror is locked in the up position.

- 7** Clean the **CCD**.

Use a brush-less blower to remove dirt and dust from the CCD. Using a blower with a brush may scratch the CCD. Do not wipe the CCD with a cloth.

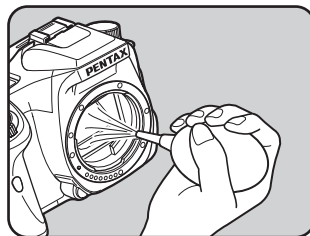

- 8** Turn the camera off.

- 9** Attach the lens after the mirror returns to its original position.

A number of dedicated accessories are available for this camera. Please contact a service center for details regarding accessories.

AC Adapter Kit K-AC10

This AC adapter supplies power from the outlet into your camera.

Cable Switch CS-205

This is a remote shutter release cord. The cord length is 0.5 m.

Remote Control F

Lets you shoot pictures from within 5 m of the front of the camera.

Flash Accessories

Auto Flash AF540FGZ

Auto Flash AF360FGZ

The AF540FGZ and AF360FGZ are P-TTL auto flash units with a maximum guide number of 54 and 36 (ISO 100/m), respectively. Their features include slave-sync flash, contrast-control-sync flash, Auto flash, high-speed sync flash, wireless flash and front/rear curtain-sync flash.

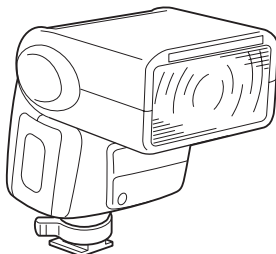

Off-camera Shoe Clip CL-10

This is a setting clip for using the AF540FGZ or AF360FGZ as a wireless slave flash.

Hot Shoe Adapter Fc**Extension Cord F5P****Off-camera Shoe Adapter F**

Use the adapters and cords to use the external flash away from the camera.

For Viewfinder**Magnifier Fb**

This viewfinder accessory is for magnifying the central area of the viewfinder.

Ref-converter A

This is an accessory that changes the viewfinder viewing angle at 90° intervals. The viewfinder magnification can be switched between 1x and 2x.

Diopter correction lens adapter M

This accessory adjusts the diopter. Install it on the viewfinder.

If it is difficult to see the viewfinder image clearly, choose one of the eight correction lens adapter M of -5 to $+3$ m⁻¹ (per meter).

Camera Case

Camera Case O-CC53

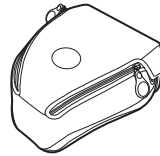

Others

The accessories below are the same as the accessories that are packaged with the camera.

ME viewfinder cap



Eyecup Fo

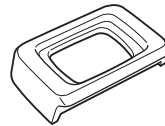

Strap O-ST53

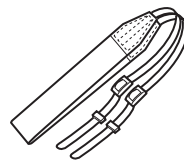











| Error Message | Description |
|---|--|
| Memory card full | The SD Memory Card is full and no more images can be saved. Insert a new SD Memory Card or delete unwanted images. (p.29, p.76) You may be able to save new images by changing the quality level or recorded pixels. (p.111, p.112) |
| No image | There are no images for playback on the SD Memory Card. |
| Camera cannot display this image | You are trying to play back an image in a format not supported by this camera. You may be able to play it back on another brand of camera or your computer. |
| No card in camera | The SD Memory Card is not inserted in the camera. (p.29) |
| Memory card error | The SD Memory Card has a problem, and image capture and playback are impossible. It may be viewable on a PC but not with this camera. |
| Card not formatted | The SD Memory Card you have inserted is unformatted or has been formatted on a computer or other device and is not compatible with this camera. Use the card after formatting it with this camera. (p.165) |
| Card locked | A locked SD Memory Card is inserted in the camera. Unlock the SD Memory Card. (p.30) |
| Card is locked Rotation information cannot be saved | |
| This image is protected Rotation information cannot be saved | The selected rotated image is protected. Remove protection from the image. (p.80) |
| Cannot use this card | The inserted card cannot be used on this camera. Insert a usable card. |
| Battery depleted | The batteries are exhausted. Install new batteries in the camera. (p.25) |
| Not enough battery remaining to clean sensor | Appears during CCD cleaning if battery set level is insufficient. Replace the battery set with a new one or use an AC adaptor (optional). (p.28) |

| Error Message | Description |
|-----------------------------------|---|
| Image folder could not be created | The maximum folder number (999) and file number (9999) are being used, and no more images can be saved. Insert a new SD Memory Card or format the card. (p.165) |
| The image is not stored | The image could not be saved because of an SD Memory Card error. |
| Settings not stored | The DPOF settings file could not be saved because SD Memory Card is full. Delete unwanted images and set DPOF again. (p.76) |
| RAW images cannot be set | DPOF cannot be applied to the RAW images. |
| RAW images are not supported | RAW images cannot be processed using the digital filter. |
| No image to be filtered | When digital filter is started from [▶] Playback] menu, this message appears if all saved images are RAW files or images captured with other cameras. |
| This image cannot be filtered | Appears when digital filter is started from Fn menu for images captured with other cameras. |
| No DPOF files | No file set with DPOF. Set DPOF and print. (p.82) |
| Printer error | There is an error with the printer and the file cannot be printed. Fix all the errors and try printing again. |
| No paper in the printer | Printer has run out of paper. Put paper in printer and print. |
| No ink in the printer | Printer has run out of ink. Replace ink and print. |
| Paper stuck in the printer | Paper is jammed in printer. Remove paper and print. |
| Data error | A data error has occurred during printing. |

We recommend checking the following items before contacting a service center.

| Problem | Cause | Remedy |
|------------------------------|---|---|
| Camera does not turn on | Batteries are not installed | Check if batteries are installed. If not, install batteries. |
| | Batteries are not installed properly | Check orientation of batteries. Re-insert batteries according to the ⊕ ⊖ symbols. (p.25) |
| | Battery power is low | Replace with a charged battery set or use the AC adapter. (p.28) |
| The shutter does not release | The lens aperture ring setting is other than the A position | Set the lens aperture ring to the A position (p.135) or select [Permitted] in [Using aperture ring] in the [C Custom Setting] menu (p.184). |
| | Flash is charging | Wait until charging is finished. |
| | No available space on SD Memory Card | Insert SD Memory Card with available space or delete unwanted images. (p.29, p.76) |
| | Recording | Wait until recording is finished. |
| The Autofocus does not work | Subject is difficult to focus on | Autofocus cannot focus well on subjects that have low contrast (the sky, white walls), dark colors, intricate designs, are moving quickly or scenery shot through a window or a net-like pattern. Lock focus on another object located at same distance (press shutter release button halfway), then aim at target and press shutter release button fully. Alternatively, use manual focus. (p.128) |
| | Subject is not in focusing area | Position subject in focus frame in middle of viewfinder. If the subject is outside the focusing area, aim the camera at the subject and lock the focus (press shutter release button halfway), then compose picture and press the shutter release button fully. |
| | Subject is too close | Move away from the subject and take a picture. |
| | The focus mode is set to MF | Set the focus mode lever to AF . (p.120) |
| | The [AF Mode] in the [📷 Rec. Mode] is set to AFC (Continuous mode) | Set the [AF Mode] in the [📷 Rec. Mode] to AFS (Single mode). (p.123) |
| | The Capture mode is set to 📷 (Moving Object) mode | Set the Capture mode to setting other than 📷 (Moving Object) mode. (p.47) |

| Problem | Cause | Remedy |
|--|--|--|
| AE lock function does not operate | AE lock is not available when set to M (Manual) mode or B (Bulb) mode | Use AE lock with any setting other than M (Manual) mode or B (Bulb) mode. |
| Flash does not discharge | When flash mode is set to [Auto discharge] or [Auto flash+Redeye reduct], the flash will not discharge if the subject is bright | Set flash mode to [Manual discharge] or [Manl flash+Redeye reduct]. (p.51) |
| | Mode dial is set to  (Flash OFF) | Set mode dial to any setting other than  (Flash OFF). (p.47) |
| | SCN (Scene) mode is set to  (Night Scene),  (Sunset),  (Candlelight) or  (Museum) | Set SCN (Scene) mode to any setting other than  (Night Scene),  (Sunset),  (Candlelight) or  (Museum). (p.47) |
| The power zoom system does not function | The camera does not have the power zoom function | Use manual zoom. (p.50) |
| USB connection with computer does not work properly* | The transfer mode is set to [PictBridge] | Set transfer mode to [PC]. |
| | An error occurred while sending USB data | Change the transfer mode to [PC-F]. |
| USB connection with printer does not work properly | The transfer mode is set to [PC] or [PC-F] | Set transfer mode to [PictBridge]. (p.86) |

In rare cases, the camera may not operate correctly due to static electricity. This can be remedied by taking the batteries out and putting them back in again. When the mirror remains in the up position, take the batteries out and put them back in again. Then, turn the power on. The mirror will retract. After the procedure is done, if the camera operates correctly, it does not require any repairs.



































* Refer to p.11 of the "PENTAX PHOTO Browser 3/PENTAX PHOTO Laboratory 3 Operating Manual" for details on connecting the camera to a PC.



| | |
|------------------|---|
| Type | TTL autofocus, auto-exposure SLR digital-still camera with built-in retractable P-TTL flash |
| Effective Pixels | 6.10 megapixels |
| Sensor | Total pixels 6.31 megapixels, interline/interlace scan CCD with a primary color filter |
| Recorded Pixels | 6M (RAW: 3008×2008/JPEG: 3008×2000 pixels), 4M (2400×1600 pixels), 1.5M (1536×1024 pixels) |
| Sensitivity | Auto, Manual (200/400/800/1600/3200: Standard Output Sensitivity) |
| File Format | RAW, JPEG (Exif2.21), DCF compliant, DPOF compatible, Print Image Matching III compatible |
| Quality Level | RAW , ★★★ (Best), ★★ (Better), and ★ (Good) |
| Storage Medium | SD Memory Card |
| Number of Shots | |

| Size | Quality Level | Capacity | | | |
|--------------------------|---------------|--------------|--------------|-------------|-------------|
| | | 1 GB | 512 MB | 256 MB | 128 MB |
| 6M 3008×2008 | RAW | Approx. 90 | Approx. 46 | Approx. 22 | Approx. 11 |
| 6M 3008×2000 | ★★★ | Approx. 330 | Approx. 167 | Approx. 78 | Approx. 34 |
| | ★★ | Approx. 607 | Approx. 311 | Approx. 149 | Approx. 70 |
| | ★ | Approx. 966 | Approx. 498 | Approx. 242 | Approx. 117 |
| 4M 2400×1600 | ★★★ | Approx. 459 | Approx. 234 | Approx. 111 | Approx. 51 |
| | ★★ | Approx. 807 | Approx. 415 | Approx. 201 | Approx. 96 |
| | ★ | Approx. 1397 | Approx. 674 | Approx. 330 | Approx. 161 |
| 1.5M 1536×1029 | ★★★ | Approx. 880 | Approx. 453 | Approx. 220 | Approx. 106 |
| | ★★ | Approx. 1397 | Approx. 722 | Approx. 354 | Approx. 173 |
| | ★ | Approx. 2151 | Approx. 1115 | Approx. 549 | Approx. 271 |

Compression: ★★★ (Best) = 1/3, ★★ (Better) = 1/6, ★ (Good) = 1/12

| | |
|-------------------|---|
| White Balance | Auto, Daylight, Shade, Cloudy, Fluorescent Light (D: Daylight, N: Neutral White, W: White), Tungsten Light, Flash, Manual |
| LCD Monitor | 2.5 inch low-temperature wide viewing field poly-silicon TFT color LCD with approx. 210,000 pixels (with backlight) |
| Playback Function | Single frame, nine-image display, zoom display (up to 12 times, scrolling possible), rotating, slideshow, histogram, bright portion |
| Digital Filter | B&W, Sepia, Color, Soft, Slim, Brightness (only for processing after shooting) |

| | |
|-----------------------|--|
| Exposure Mode | <p>P Program, Tv Shutter priority, Av Aperture priority, M Manual, B Bulb Picture mode  Auto Picture,  Portrait,  Landscape,  Macro,  Moving Object,  Night Scene Portrait,  Flash OFF</p> <p>Scene mode  Night Scene,  Surf & Snow,  Text,  Sunset,  Kids,  Pet,  Candlelight,  Museum.</p> |
| Shutter | Electronically controlled vertical-run focal-plane shutter, Speed range (1) Auto 1/4000 to 30 sec. (stepless), (2) Manual 1/4000 to 30 sec. [1/2 EV step or 1/3 EV step] (3) Bulb, Electromagnetic release, Shutter lock by setting Main switch in OFF position. |
| Lens Mount | Pentax KAF bayonet mount (K-mount with AF coupler, lens information contacts) |
| Lens Used | Pentax KAF2 (not power zoom compatible), KAF mount lenses, KA mount lenses |
| Autofocus System | TTL phase-matching autofocus system (SAFOX VIII), AF operational brightness range: EV 0 to 19 (at ISO 200 with f/1.4 lens), Focus lock available, Focus Mode: A.F.S (Single)/ A.F.C (Continuous)/ MF , Adjustable AF point |
| Viewfinder | Penta-mirror viewfinder, Natural-Bright-Matte II focusing screen, Field of view: 96%, Magnification 0.85× (with 50 mm f/1.4 lens at ∞), Diopter: -2.5m ⁻¹ to +1.5m ⁻¹ (per meter) |
| Viewfinder Indication | Focus information:  is lit when in-focus and blinking when unable to focus,  is lit=Built-in flash ready,  is blinking=Flash should be used or incompatible lens is being used, Shutter speed, Confirm Sensitivity, Aperture value, e-dial enabled indicator,  =AE lock, Capacity remaining,  =Exposure compensation, A.F.C =Continuous mode, Picture mode icon, Scene mode icon, MF =Manual focus, ISO =ISO warning |
| LCD Panel Display |  is lit=Built-in flash ready,  is blinking=Flash should be used or incompatible lens is being used,  =Auto discharge,  =Auto flash+Redeye reduct,  =Single frame shooting,  =Continuous shooting,  =Self-timer,  =Remote control shooting,  =Battery exhaustion warning,  =Auto bracketing exposure (exposure setting steps can be set to 1/2 EV or 1/3 EV),  =Center-weighted metering,  =Spot metering,  =AF Point Select,  =Center of AF Point, Shutter speed, Aperture value, White Balance, Capacity remaining and  =Exposure compensation, PC (mass storage)/ Pb (PictBridge) appears when the USB cable is connected |
| Preview Function | Digital Preview: Composition, exposure and focus confirmation Optical Preview: Depth of field confirmation (electronically controlled and usable in all exposure modes) |
| Self-timer | Electronically controlled with delay time of 12 sec./2 sec. (with mirror up function). Start by pressing shutter release button. Operation confirmation: Possible to set beep. Can be cancelled after operation |
| Mirror | Quick-return mirror, mirror up function (2 sec. self-timer) |
| Auto Bracket | Three frames (under exposed, proper exposure and overexposed) are shot continuously with exposure bracketing. (Selectable between 1/2 EV and 1/3 EV for Exposure setting steps) |

| | | |
|-----------------------------------|--|---|
| Exposure Meter/ Metering Range | TTL multi (16)-segment metering, Metering range from EV 1 to EV 21.5 at ISO 200, with 50 mm f/1.4 lens, Center-weighted and Spot metering mode can be set | |
| EV Compensation | ±2.0 EV (Selectable between 1/2 EV and 1/3 EV for Exposure setting steps) | |
| AE Lock | Button type (timer type default: 20 sec. or continuous as long as the shutter button is halfway pressed) | |
| Built-in Flash | P-TTL built-in flash with serial control, GN 15.6 (ISO 200/m), Angles of coverage: 18 mm lens angle of view, Flash synchronization speed range at 1/180 sec. and slower, Daylight-sync flash, Slow-speed-sync flash, ISO range = P-TTL: 200 to 3200 | |
| External Flash Sync | Hot shoe with X-contact, which couples with Pentax dedicated auto flashes, ISO range = P-TTL: 200-3200, Automatic flash, Red-eye reduction flash function, High-speed-sync, wireless-sync with PENTAX dedicated flash. | |
| Custom Function | 18 functions can be set | |
| Time Function | World Time settings for 70 cities (28 time zones) | |
| Power | Two CR-V3, four AA lithium, AA Ni-MH rechargeable, or AA alkaline batteries | |
| Battery Exhaustion | Battery exhaustion symbol  is lit. (The shutter is locked and no indication appears in the viewfinder when  starts blinking) | |
| In/Out Port | USB/Video terminal (USB 2.0 (high speed compatible)), DC input terminal, Cable switch terminal | |
| Video Output Format | NTSC/PAL | |
| PictBridge | Compatible printer Print mode | PictBridge-compatible printer Print One, Print All, DPOF AUTOPRINT |
| Dimensions and Weight | 129.5 mm (W) × 92.5 mm (H) × 70 mm (D) 560 g (body only without batteries) | |
| Accessories | Hot shoe cover Fk, Eyecup Fo, ME viewfinder cap, Body mount cover, USB Cable I-USB17, Video cable I-VC28, Software (CD-ROM) S-SW53, Strap O-ST53, Four AA alkaline batteries, Operating manual (this book) and PENTAX PHOTO Browser 3/ PENTAX PHOTO Laboratory 3 operating manual | |
| Languages | English, French, German, Spanish, Italian, Swedish, Dutch, Russian, Korean, Chinese (Traditional / Simplified) and Japanese | |

Specifications for Remote Control F (Optional)

| | |
|----------------|--|
| Remote Control | Infrared remote control unit, captured about three seconds after remote control shutter button is pressed or immediate capture on pressing the button, operating distance = within approx. 5 m in front of the camera. |
| Power | One lithium battery (CR1620) |
| Dimensions | 22 mm (W) × 53 mm (H) × 6.5 mm (D) |
| Weight | 7 g (including battery) |

AdobeRGB

Color space recommended by Adobe Systems, Inc. for commercial printing. Wider range of color reproduction than sRGB. Covers most of the color range so colors only available when printed are not lost when editing images on a computer. When image is opened by non-compatible software, the colors look lighter.

AE Metering

Brightness of subject is measured to determine exposure. In this camera, select from [Multi-segment Metering], [Center-weighted Metering] and [Spot Metering].

Aperture

The aperture increases or reduces the light beam (thickness) passing through the lens to the CCD.

6

Appendix

Auto Bracket

For automatically changing the shooting conditions. When the shutter button is pressed, three images are shot. The first one has no compensation, the second is underexposed and the third is over-exposed.

Bright Portion

Overexposed area in the image loses contrast and appears white.

Camera Shake (Blur)

When the camera moves while the shutter is open, the entire image appears blurred. This occurs more often when shutter speed is low. Prevent camera shake by raising the sensitivity, using the flash, and raising the shutter speed. Alternatively, use a tripod to stabilize the camera. As camera shakes are mostly likely to occur when pressing the shutter release button, use the self-timer, the remote control unit, and the cable switch to prevent camera movement.

CCD (Charge Coupled Devices)

Photography element which converts the light entering through the lens into electric signals that create the image.

Color space

A defined range of colors from the spectrum which are used. In digital cameras, [sRGB] is defined as the standard by Exif. In this camera, [AdobeRGB] is also used because of the richer color expression over sRGB.

Color Temperature

This numerically expresses the color of the light source illuminating the subject. This is indicated in absolute temperature, using Kelvin (K) units. The color of light shifts to a bluish color as the color temperature rises, and to a reddish color as the color temperature falls.

DCF (Design Rule for Camera File System)

A digital camera file system standard established by the Japan Electronics and Information Technology Industries Association (JEITA).

Depth of Field

Area of focus. This depends on the aperture, lens focal length, and distance to the subject. For example, select a smaller aperture to increase the depth of field or use a larger aperture to decrease the depth of field.

DPOF (Digital Print Order Format)

Rules for writing information onto a card with recorded images regarding the specific images and number of copies to be printed. Prints can easily be made by taking images to a DPOF photo printing store.

EV (Exposure Value)

Exposure value is determined by the combination of the aperture value and the shutter speed.

EV Compensation

Process of adjusting the image brightness by changing the shutter speed and aperture value.

Exif (Exchangeable image file format for digital still camera)

A standard digital camera file format established by the Japan Electronics and Information Technology Industries Association (JEITA).

Focus point

Position in the viewfinder that determines focus. In this camera, select from [Auto], [Select] and [Center].

Histogram

A graph that shows the darkest and brightest points in an image. The horizontal axis represents the brightness and the vertical axis represents the number of pixels. This is useful when you wish to refer to the exposure status of an image.

JPEG

An image compression method. The image is recorded in JPEG format when the quality level is set to ★★★ (Best), ★★ (Better), or ★ (Good). Images recorded in JPEG format are suited for viewing on your PC or for attaching to e-mail.

ND (Neutral Density) Filter

A filter with many saturation levels that adjusts the brightness without affecting the picture itself.

6

Appendix

Noise Reduction

Process to reduce noise (image roughness or unevenness) caused by low shutter speed.

NTSC/PAL

These are video output formats. NTSC is mainly used in Japan, North America, and South Korea. PAL is mainly used in Europe and in China.

Quality Level

This refers to the image compression ratio. The lower the compression, the more detailed the image. The image becomes rougher as the compression rate rises.

RAW data

Unedited image data output from the CCD. RAW data is data before being internally processed by the camera. Camera settings at the time of capture, such as White Balance, Contrast, Saturation, Tone, Color Space, Sensitivity and Sharpness can be set for each frame after shooting. In addition, RAW data is 12 bit data that contains 16 times the information of 8 bit JPEG and TIFF data. Rich gradations are possible. Transfer RAW data to your computer and use the provided software to create image data with different settings, such as JPEG or TIFF.

Recorded Pixels

Indicates the size of the image by the number of pixels. The more pixels that compose a picture, the larger the image size.

Sensitivity

The degree of light. With a high sensitivity, images can be shot with a high shutter speed even in dark places, reducing camera shake. However, images with high sensitivity are more susceptible to noise.

Shutter Speed

The length of time that the shutter is open and light strikes the CCD. The amount of light that strikes the CCD can be changed by altering the shutter speed.

sRGB (standard RGB)

International standard of color space established by the IEC (International Electrotechnical Commission). This is defined from color space for PC monitors and is also used as the standard color space for Exif.

Vignetting

Vignetting occurs when corners of pictures are blackened because the subject was blocked by the hood or filter or the flash was blocked.

White Balance

While shooting, color temperature is adjusted to match the light source so that the subject appears to have correct color.

Symbols

| | |
|----------------------------|----------|
| [Rec. Mode] Menu ... | 100, 178 |
| [Playback] Menu | 100, 178 |
| [Set-up] Menu | 101, 179 |
| [Custom Setting] | |
| Menu | 102, 180 |
| Auto Picture | 43, 47 |
| Portrait | 47 |
| Landscape | 47 |
| Macro | 47 |
| Moving Object | 47 |
| Night Scene Portrait | 47 |
| Flash OFF | 47 |
| Night Scene | 48 |
| Surf & Snow | 48 |
| Text | 48 |
| Sunset | 48 |
| Kids | 48 |
| Pet | 48 |
| Candlelight | 48 |
| Museum | 48 |
| button | 95, 97 |
| button | 96 |
| button | 95 |
| button | 97 |
| button | 95 |
| Preview | 148, 149 |

A

| | |
|--------------------------|-----|
| AC Adapter | 28 |
| Adding the Date | 82 |
| AdobeRGB | 119 |
| AE lock | 144 |
| AE Metering | 132 |
| AE-L button | 95 |
| AF Mode | 123 |
| AF Point | 124 |

| | |
|--------------------------------------|--------|
| AF360FGZ | 156 |
| AF540FGZ | 156 |
| AF.C (Continuous mode) | 123 |
| AF.S (Single mode) | 123 |
| Alkaline batteries | 26 |
| Aperture | 131 |
| Aperture Priority Mode Av ... | 138 |
| Auto Bracket | 145 |
| Auto Picture | 43, 47 |
| Auto Power Off | 172 |
| AF (Autofocus) | 120 |
| Autofocus AF | 120 |
| Automatic Sensitivity | |
| Correction | 117 |
| AV Equipment | 72 |
| Av (Aperture Priority) | |
| mode | 138 |

B

| | |
|-----------------------------------|----------|
| B&W (Digital Filter) | 73 |
| Batteries | 25 |
| Beep | 166 |
| Bright | 110 |
| Bright Portion | 163, 174 |
| Brightness (Digital Filter) | 73 |
| Brightness of the LCD | |
| Monitor | 171 |
| Built-in flash | 51, 150 |
| B (Bulb) Mode | 142 |
| Bulb Mode B | 142 |

C



| | |
|---------------------------|--------|
| Cable Switch | 142 |
| Candlelight | 48 |
| Capture Information | 17, 18 |
| Card access lamp | 15 |
| CCD Cleaning | 185 |
| Center-weighted | 133 |

- Cloudy (White Balance) 114
- Color (Digital Filter) 73
- Color space 119
- Color Temperature 115
- Confirm Sensitivity 122
- Continuous Autofocus 127
- Continuous mode **AFC** 123
- Continuous Shooting 55
- Contrast 113
- Contrast-Control-Sync
- Flash 162
- Correct exposure 130
- CR-V3 26
- Custom Function 102
- [**C** Custom Setting]
- Menu 102, 180

- D**
- Date Adjust 35
- Date change 166
- Daylight (White Balance) 114
- Daylight-Sync Shooting 54
- Default Setting 33, 178
- Delete 76
- Delete All Images 77
-  (Delete) button 96
- Deleting a Single Image 76
- Depth of Field 131
- Digital Filter 73
- Digital Preview 148
- Diopter Adjust 39
- Direct Printing 85
- Display Language 170
- Display Style 163
- DPOF AUTOPRINT 92
- DPOF Settings 82
- Drive Mode 104





- E**
- e-dial 95
- Error Message 190







- EV Compensation 143
-  **Av** (EV Compensation/Av) button 95
- Exposure 130
- Exposure metering timer 146
- Exposure Mode 134
- Exposure Warning 137, 139, 141
- External flash 156

- F**
- File # 173
- Filter 73
- Fireworks 142
- Fix Exposure 127
- Fix Focus 126
- Flash 51, 150
- Flash (White Balance) 114
- Flash Compensation 150
- Flash Off 47
- Flash OFF  47
-  **UP** (Flash pop-up) button 95
- Fluorescent Light (White Balance) 114
- Fn** button 95, 97
- Fn Menu 104
- Focus Indicator 103, 128
- Focus Lock 126
- Focus mode lever 95
- Focusing 120
- Folder Name 172
- Format 165
- Four-way controller () 95, 97

- G**
- Guide display 16, 170

- H**
- High-Speed Flash Sync

| | |
|---|---------|
| Mode | 158 |
| Histogram | 19, 174 |
| I | |
| Image Tone | 110 |
| INFO button | 95, 97 |
| Instant Review | 173 |
| ISO Sensitivity | 117 |
| ISO Sensitivity Warning Display | 118 |
| K | |
| Kids  | 48 |
| L | |
| Landscape  | 47 |
| Language | 33 |
| Last Memory | 178 |
| LCD Monitor | 16 |
| LCD panel | 22 |
| Lens | 37, 182 |
| Lens unlock button | 38, 94 |
| Lithium batteries | 26 |
| M | |
| Macro  | 47 |
| Main switch | 94, 96 |
| MF (Manual focus) | 128 |
| Manual focus MF | 128 |
| Manual White Balance | 115 |
| Matte Field | 129 |
| MENU button | 95, 96 |
| Menu Operation | 98 |
| Meter Operating Time | 133 |
| Mirror Up | 64, 186 |
| Mode dial | 95, 106 |
| Mode Palette | 49 |
| Moving Object  | 47 |
| Multiple Flashes | 161 |
| Multi-segment | 132 |
| Museum  | 48 |

| | |
|--|----------|
| N | |
| Natural | 110 |
| Night Scene  | 48 |
| Night Scene (Bulb Mode) | 142 |
| Night Scene Portrait  | 47 |
| Ni-MH | 26 |
| Ni-MH rechargeable batteries | 26 |
| Nine-Image Display | 68 |
| Noise Reduction | 142 |
| NTSC | 171 |
| O | |
| OK button | 95, 97 |
| Optical Preview | 148 |
| Optional Accessories | 187 |
| P | |
| P (Program) Mode | 135 |
| PAL | 171 |
| PC-F | 193 |
| Pet  | 48 |
| PictBridge | 85 |
| Pixels | 111 |
| Playback | 18, 65 |
|  (Playback) button | 95, 97 |
| [ Playback] Menu | 100, 178 |
| Playback Time | 27 |
| Portrait  | 47 |
| Power | 32 |
| Press fully | 45 |
| Press halfway | 45 |
| Preview  | 148, 149 |
| Preview Display | 174 |
| Preview Method | 149 |
| Print All | 90 |
| Print One | 88 |
| Print Service | 82 |
| Printer connection | 87 |
| Program Mode P | 135 |
| Protect | 80 |

| | |
|---|-----|
|  (Protect) button | 97 |
| P-TTL (Auto) | 157 |
| P-TTL (Flash) | 159 |

Q

| | |
|---------------------|---------|
| Quality Level | 31, 112 |
|---------------------|---------|

R

| | |
|--|----------|
| RAW | 112 |
| Rear Curtain Sync Flash | 160 |
| [ Rec. Mode] Menu ... | 100, 178 |
| Recorded Pixels | 31, 111 |
| Red-eye reduction | 54, 160 |
| Remaining image storage capacity | 27 |
| Remote Control | 61 |
| Reset | 175, 176 |
| Rotate | 66 |

S

| | |
|---|------------|
| Saturation | 113 |
| SCN (Scene) | 47 |
| SD Memory Card | 29 |
| Select&Delete | 78 |
| Self-Timer | 57 |
| Sensitivity | 117 |
| Sepia (Digital Filter) | 73 |
| [ Set-up] Menu | 101, 179 |
| Shade (White Balance) | 114 |
| Sharpness | 113 |
| Shutter Priority Mode Tv | 136 |
| Shutter release button | 45, 94, 96 |
| Shutter speed | 130 |
| Single mode AfS | 123 |
| Slideshow | 70, 164 |
| Slim (Digital Filter) | 73 |
| Soft (Digital Filter) | 73 |
| Spot Metering | 133 |
| sRGB | 119 |
| Strap | 24 |

| | |
|---|---------|
| Sunset  | 48 |
| Superimpose AF Area | 21, 124 |
| Surf & Snow  | 48 |

T

| | |
|--|-----|
| Text  | 48 |
| Transfer Mode | 86 |
| Tungsten Light (White Balance) | 114 |
| TV | 72 |
| Tv (Shutter Priority) mode ... | 136 |

U

| | |
|---------------------------|-----|
| USB cable | 85 |
| Using aperture ring | 184 |

V

| | |
|---------------------------|--------|
| Video cable | 72 |
| Video Output Format | 171 |
| Viewfinder | 20, 39 |
| Vignetting | 201 |

W

| | |
|---------------------|-----|
| White Balance | 114 |
| Wireless Mode | 158 |
| World Time | 167 |

Z

| | |
|--------------------|----|
| Zoom Display | 67 |
| Zoom Lens | 50 |

All PENTAX cameras purchased through authorized bona fide photographic distribution channels are guaranteed against defects of material or workmanship for a period of twelve months from date of purchase. Service will be rendered, and defective parts will be replaced without cost to you within that period, provided the equipment does not show evidence of impact, sand or liquid damage, mishandling, tampering, battery or chemical corrosion, operation contrary to operating instructions, or modification by an unauthorized repair shop. The manufacturer or its authorized representatives shall not be liable for any repair or alterations except those made with its written consent and shall not be liable for damages from delay or loss of use or from other indirect or consequential damages of any kind, whether caused by defective material or workmanship or otherwise; and it is expressly agreed that the liability of the manufacturer or its representatives under all guarantees or warranties, whether expressed or implied, is strictly limited to the replacement of parts as hereinbefore provided. No refunds will be made on repairs by nonauthorized PENTAX service facilities.

Procedure During 12-month Warranty Period

Any PENTAX which proves defective during the 12-month warranty period should be returned to the dealer from whom you purchased the equipment or to the manufacturer. If there are no representatives of the manufacturer in your country, send the equipment to the manufacturer, with postage prepaid. In this case, it will take a considerable length of time before the equipment can be returned to you owing to the complicated customs procedures required. If the equipment is covered by warranty, repairs will be made and parts replaced free of charge, and the equipment will be returned to you upon completion of servicing. If the equipment is not covered by warranty, regular charges of the manufacturer or of its representatives will apply. Shipping charges are to be borne by the owner. If your PENTAX was purchased outside of the country where you wish to have it serviced during the warranty period, regular handling and servicing fees may be charged by the manufacturer's representatives in that country. Notwithstanding this, your PENTAX returned to the manufacturer will be serviced free of charge according to this procedure and warranty policy. In any case, however, shipping charges and customs clearance fees to be borne by the sender. To prove the date of your purchase when

required, please keep the receipt or bills covering the purchase of your equipment for at least a year. Before sending your equipment for servicing, please make sure that you are sending it to the manufacturer's authorized representatives or their approved repair shops, unless you are sending it directly to the manufacturer. Always obtain a quotation for the service charge, and only after you accept the quoted service charge, instruct the service station to proceed with the servicing.

- **This warranty policy does not affect the customer's statutory rights.**
- **The local warranty policies available from PENTAX distributors in some countries can supersede this warranty policy. Therefore, we recommend that you review the warranty card supplied with your product at the time of purchase, or contact the PENTAX distributor in your country for more information and to receive a copy of the warranty policy.**



Batteries do not belong in household refuse. Please take care that your used batteries are disposed at an appropriate collection point. Old or defective cameras likewise do not belong in household refuse. Please take care to dispose of your old cameras in an environmentally-friendly way or send them back to us.



The CE Mark is a Directive conformity mark of the European Union.

For customers in USA

STATEMENT OF FCC COMPLIANCE

This device complies with Part 15 of the FCC Rules. Operation is subject to the following two conditions: (1) This device may not cause harmful interference, and (2) this device must accept any interference received, including interference that may cause undesired operation.

Changes or modifications not approved by the party responsible for compliance could void the user's authority to operate the equipment.

This equipment has been tested and found to comply with the limits for a Class B digital device, pursuant to part 15 of the FCC Rules.

These limits are designed to provide reasonable protection against harmful interference in a residential installation. This equipment generates, uses and can radiate frequency energy and, if not installed and used in accordance with the instructions, may cause harmful interference to radio communications. However, there is no guarantee that interference will not occur in a particular installation.

If this equipment does cause harmful interference to radio or television reception, which can be determined by turning the equipment off and on, the user is encouraged to try to correct the interference by one or more of the following measures:

- Reorient or relocate the receiving antenna.
- Increase the separation between the equipment and receiver.
- Connect the equipment into an outlet on a circuit different from that to which the receiver is connected.
- * Consult the dealer or an experienced radio/TV technician for help.

For customers in Canada

This Class B digital apparatus meets all requirements of the Canadian Interference - Causing Equipment Regulations.

Pour les utilisateurs au Canada

Cet appareil numérique de la classe B respecte toutes les exigences du Règlement sur le matériel brouilleur du Canada.

Declaration of Conformity
According to 47CFR, Parts 2 and 15 for
Class B Personal Computers and Peripherals

We: PENTAX Imaging Company
A Division of PENTAX of America, Inc.

Located at: 600 12th Street, Suite 300
Golden, Colorado 80401 U.S.A.
Phone: 303-799-8000 FAX: 303-790-1131

Declare under sole responsibility that the product identified herein complies with 47CFR Parts 2 and 15 of the FCC rules as a Class B digital device. Each product marketed is identical to the representative unit tested and found to be compliant with the standards. Records maintained continue to reflect the equipment being produced can be expected to be within the variation accepted, due to quantity production and testing on the statistical basis as required by 47CFR §2.909. Operation is subject to the following two conditions: (1) This device may not cause harmful interference, and (2) This device must accept any interference received, including interference that may cause undesired operation. The above named party is responsible for ensuring that the equipment complies with the standards of 47CFR §15.101 to §15.109.

Product Name: PENTAX Digital Still Camera

Model Number: ***K110D***

Contact person: Customer Service Manager

Date and Place: June, 2006, Colorado

Information on disposal for users



1. In the European Union

If your product is marked with this symbol, it means that used electrical/electronic products should not be mixed with general household waste. There exists a separate collection system for these products.

Used electric/electronic equipment must be treated separately and in accordance with legislation that requires proper treatment, recovery and recycling of these products. Following the implementation by member states, private households within the EU states may return their used electrical/electronic equipments to designated collection facilities free of charge*. In some countries your local retailer may also take back your old product free of charge if you purchase a similar new one.

*Please contact your local authority for further details.

By disposing of this product correctly you will help ensure that the waste undergoes the necessary treatment, recovery and recycling and thus prevent potential negative effects on the environment and human health which could otherwise arise due to inappropriate waste handling.

2. In other countries outside the EU

If you wish to discard this product, please contact your local authorities and ask for the correct method of disposal.

For Switzerland: Used electrical/electronic equipment can be returned free of charge to the dealer, even when you don't purchase a new product. Further collection facilities are listed on the home page of www.swico.ch or www.sens.ch.

Memo

Memo

Memo

- PENTAX Corporation** 2-36-9, Maeno-cho, Itabashi-ku, Tokyo 174-8639, JAPAN
(<http://www.pentax.co.jp/english>)
- PENTAX Europe GmbH
(European
Headquarters)** Julius-Vosseler-Strasse, 104, 22527 Hamburg, GERMANY
(HQ - <http://www.pentaxeurope.com>)
(Germany - <http://www.pentax.de>)
Hotline: 0180 5 736829 / 0180 5 PENTAX
Austria Hotline: 0820 820 255 (<http://www.pentax.at>)
- PENTAX U.K. Limited** PENTAX House,
Heron Drive, Langley, Slough, Berks SL3 8PN, U.K.
(<http://www.pentax.co.uk>) Hotline: 0870 736 8299
- PENTAX France S.A.S.** 112 Quai de Bezons - BP 204, 95106 Argenteuil Cedex, FRANCE
(<http://www.pentax.fr>)
Hotline: 0826 103 163 (0,15€ la minute)
Fax: 01 30 25 75 76
Email: http://www.pentax.fr/_fr/photo/contact.php?photo&contact
- PENTAX (Schweiz) AG** Widenholzstrasse 1 Postfach 367 8305 Dietlikon, SWITZERLAND
(<http://www.pentax.ch>)
- PENTAX Scandinavia AB** P.O. Box 650, 75127 Uppsala, SWEDEN
(<http://www.pentax.se>)
- PENTAX Imaging Company**
A Division of PENTAX of America, Inc.
(Headquarters)
600 12th Street, Suite 300 Golden, Colorado 80401, U.S.A.
(PENTAX Service Department)
12000 Zuni Street, Suite 100B
Westminster, Colorado 80234, U.S.A.
(<http://www.pentaximaging.com>)
- PENTAX Canada Inc.** 1770 Argentinia Road Mississauga, Ontario L5N 3S7, CANADA
(<http://www.pentax.ca>)



Specifications and external dimensions are subject to change without notice.